

Panasonic[®]



SVGA Monitor/Receiver Operating Instructions

CT-3697VY



TQB2AA0320 90512
PRINTED IN USA

Table of Contents

Safety Instructions	2	Favorite Channel	43
Important Information	4	Ch (Channel) Scan.....	43
Congratulations	5	Fav (Favorite) Ch (Channel) Select	43
Customer Record	5	Channel Caption	45
Technical Assistance.....	5	Preset Caption	45
Care and Cleaning	5	Manual Caption.....	46
Specifications	6	Front Control Panel Lock	47
Installation	7	PC Mode	48
Video Monitor/Receiver Location	7	Rear PC Input Connections	48
Optional Cable Connections	7	Front PC Input Connections	49
Power Supply Cord	7	Trilingual Animated Icons	50
TV Antenna/Cable Connection.....	7	PC Mode Icons	50
Other Video Equipment.....	8	Menu Navigation	50
Front Control Panel	9	Picture Adjustments	50
Quick Reference Front Control Panel Operation	9	Picture Norm	50
Optional Equipment Connection		Video Adjustments	51
and Operation	10	Other Adjustments	52
To Audio AMP Connection.....	10	Audio Adjustments	53
Audio/Video Connection.....	11	Audio Norm	53
TV Mode	12	Audio Adjustments	53
Trilingual Animated Icons	12	Other Adjustments	54
TV Mode Icons	12	TV/PC/DTV Mode	56
Menu Navigation	12	Set Up Options	56
Menu Language Selection	12	Auto Power On.....	56
Picture Adjustments	13	Geometric Corr (Correction).....	57
Picture Norm	13	Display Adj (Adjustment)	59
Video Adjustments	13	Input Select	61
Other Adjustments	14	DTV Mode	62
Audio Adjustments	16	Component Video Connection	62
Audio Norm	16	Trilingual Animated Icons	63
Audio Adjustments	16	DTV Mode Icons	63
Other Adjustments	17	Menu Navigation	63
TV/PC/DTV Mode	19	Picture Adjustments	63
Set Up Options	20	Picture Norm	63
Clock	20	Video Adjustments	64
Auto Clock.....	20	Other Adjustments	65
Manual Clock	23	Audio Adjustments	66
Set Day	24	Audio Norm	66
Auto Power On.....	24	Audio Adjustments	66
Geometric Corr (Correction).....	25	Other Adjustments	67
Mode	26	TV/PC/DTV Mode	69
Auto Program	26	Set Up Options	70
Manual Program.....	27	Auto Power On.....	70
 on Mute.....	28	Aspect Ratio.....	70
 Mode.....	29	Color Matrix.....	71
Lock	30	Geometric Corr (Correction).....	72
V-Chip Parental Lock	30	Troubleshooting	73
Lock Mode.....	30	Troubleshooting Chart	73
Motion Picture	32	Computer Resolution Adjustments	74
Motion Picture Ratings Chart	34	Windows Version 95/98	74
TV Parental	35	Windows Version 3.x	76
TV Parental Guide Ratings Chart.....	38		
Blocking Message	39		
Timer Options	40		
Sleep Timer.....	40		
Timer 1 and Timer 2.....	41		
Input Select	42		

Read these instructions completely before operating.
 Contents are subject to change without notice or obligation.
 Copyright 1999 by Matsushita Electric Corporation of America. All rights reserved.
 Unauthorized copying and distribution is a violation of law.

Safety Instructions

	WARNING RISK OF ELECTRIC SHOCK DO NOT OPEN	
WARNING: To reduce the risk of electric shock do not remove cover or back. No user-serviceable parts inside. Refer servicing to qualified service personnel.		



The lightning flash with arrow head within a triangle is intended to tell the user that parts inside the product are a risk of electric shock to persons.



The exclamation point within a triangle is intended to tell the user that important operating and servicing instructions are in the papers with the appliance.

Note To CATV System Installer: This reminder is provided to call the CATV system installer's attention to article 820-40 of the National Electric Code that provides guidelines for proper grounding and, in particular, specifies that the cable ground shall be connected to the grounding system of the building, as close to the point of cable entry as practical.

Safety Instructions For Monitor/Receivers

1. Read and apply the operating instructions provided with your monitor/receiver.
2. Read all of the instructions given here and retain them for later use.
3. Unplug this monitor/receiver from the wall outlet before cleaning. Do not use liquid or aerosol cleaners. Use a damp cloth for cleaning.
4. Do not use attachments not recommended by the monitor/receiver manufacturer as they may cause hazards.
5. Do not use this monitor/receiver near water. For example: Avoid placing it near a bathtub, washbowl, kitchen sink, or laundry tub, in a wet basement, or near a swimming pool, etc.
6. Do not place this monitor/receiver on an unstable cart, stand, or table. The monitor/receiver may fall, causing serious injury to a child or adult and serious damage to the appliance. Use only with a cart or stand recommended by the manufacturer, or sold with the monitor/receiver. Wall or shelf mounting should follow the manufacturer's instructions, and should use a mounting kit approved by the manufacturer.
- 6a. An appliance and cart combination should be moved with care. Quick stops, excessive force, and uneven surfaces may cause the appliance and cart combination to overturn.
7. Slots and openings in the cabinet and the back or bottom are provided for ventilation, and to insure reliable operation of the monitor/receiver and to protect it from overheating. These openings must not be blocked or covered. The openings should never be blocked by placing the monitor/receiver on a bed, sofa, rug or other similar surface. This monitor/receiver should never be placed near or over a radiator or heat register. This monitor/receiver should not be placed in a built-in installation such as a bookcase unless proper ventilation is provided.
8. Operate only from the type of power source indicated on the marking label. If you are not sure of the type of power supplied to your home consult your television dealer or local power company. For television receivers designed to operate from battery power, refer to the operating instructions.
9. This monitor/receiver is equipped with a polarized alternating-current line plug (a plug having one blade wider than the other). This plug will fit into the power outlet only one way. This is a safety feature. If you are unable to insert the plug fully into the outlet, try reversing the plug. If the plug should still fail to fit, contact your electrician to replace your obsolete outlet. Do not defeat the safe purpose of the polarized plug.
10. Do not allow anything to rest on the power cord. Do not locate this monitor/receiver where the cord will be abused by persons walking on it.
11. Follow all warnings and instructions marked on the monitor/receiver.
12. Do not overload wall outlets and extension cords as this can result in fire or electric shock.
13. Never push objects of any kind in to this monitor/receiver through cabinet slots as they may touch dangerous voltage points or short out parts that could result in a fire or electric shock. Never spill liquid of any kind on the monitor/receiver.



14. If an outside antenna is connected to the decoder equipment, be sure the antenna system is grounded so as to provide some protection against voltage surges and built up static charges. In the U.S. Section 810 of the National Electrical Code, ANSI/NFPA 70, and in Canada Part 1 of the Canadian Electrical Code provides information with respect to proper grounding of the mast and supporting structure, grounding of the lead-in wire to an antenna discharge unit, size of grounding conductors, location of antenna-discharge unit, connection to grounding electrodes, and requirements for the grounding electrode. See Figure.

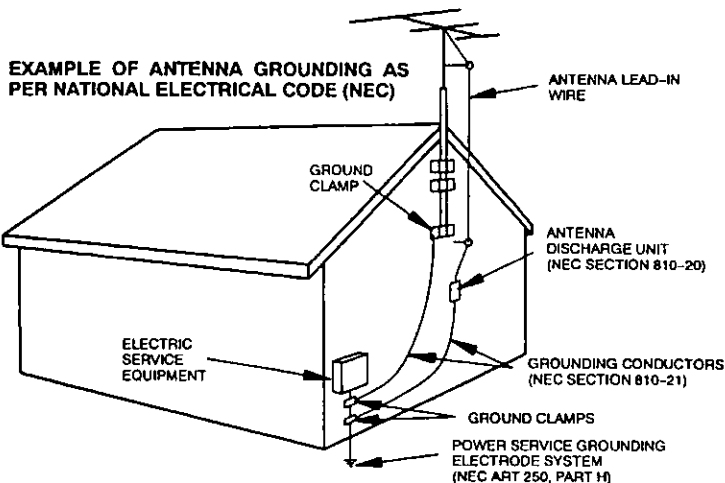

15. For added protection for this monitor/receiver during a lightning storm, or when it is left unattended and unused for long periods of time, unplug it from the wall outlet and disconnect the antenna. This will prevent damage to the decoder due to lightning and power-line surges.
16. An outside antenna system should not be located in the vicinity of overhead power lines or other electric light or power circuits, or where it can fall into such power lines or circuits. When installing an outside antenna system extreme care should be taken to keep from touching such power lines or circuits as contact with them might be fatal.
17. Unplug this monitor/receiver from the wall outlet, and refer servicing to qualified service personnel under the following conditions:
- a. When the power cord or plug is damaged or frayed.
 - b. If liquid has been spilled into the monitor/receiver.
 - c. If the monitor/receiver has been exposed to rain or water.
 - d. If the monitor/receiver does not operate normally by following the operating instructions. Adjust only those controls that are covered by the operating instructions as improper adjustment of other controls may result in damage and will often require extensive work by a qualified technician to restore the monitor/receiver to normal operation.
 - e. If the monitor/receiver has been dropped or the cabinet has been damaged.
 - f. When the monitor/receiver exhibits a distinct change in performance - this indicates a need for service.
18. Do not attempt to service this monitor/receiver yourself as opening or removing covers may expose you to dangerous voltage or other hazards. Refer all servicing to qualified service personnel.
19. When replacement parts are required, be sure the service technician has used replacement parts specified by the manufacturer that have the same characteristics as the original part. Unauthorized substitutions may result in fire, electric shock, or other hazards.
20. Upon completion of any service or repairs to this monitor/receiver, ask the service technician to perform routine safety checks to determine that the decoder is in safe operating condition.
21. **WARNING: To prevent fire or shock hazard, do not expose this appliance to rain or moisture.**
22. **CAUTION: TO PREVENT ELECTRIC SHOCK DO NOT USE THIS (POLARIZED) PLUG WITH A RECEPTACLE OR OTHER OUTLET UNLESS THE BLADES CAN BE FULLY INSERTED TO PREVENT BLADE EXPOSURE.**

NOTE: This equipment is designed to operate in the U.S.A. Canada and other countries where the broadcasting system and AC house current is exactly the same as in the U.S.A. and Canada.

Important Information Regarding Use of Video Games, Computers, Teletext or Other Fixed Image Displays.

The extended use of fixed image program material can cause a permanent "shadow image" on the picture tube. This background image is viewable on normal programs in the form of a stationary fixed image. This type of irreversible picture tube deterioration can be limited by observing the following steps:

- A. Reduce the brightness/contrast setting to a minimum viewing level.
- B. Do not display the fixed image for extended periods of time.
- C. Turn the power off when not in actual use.

NOTE: The marking or retained image on the picture tube resulting from fixed image use is not an operating defect and as such is not covered by Warranty. This product is not designed to display fixed image patterns for extended periods of time.

IMPORTANT INFORMATION

Important Information

FCC STATEMENT:

This equipment was tested and found to comply within the limits for a Class B digital device, pursuant to Part 15 of the FCC rules. These limits are designed to provide reasonable protection against harmful interference in a residential installation.

This equipment generates, uses and can radiate radio frequency energy and, if not installed and used in accordance with the instructions, may cause harmful interference with radio communications. However, there is no guarantee that interference will not occur in a particular installation. If this equipment does cause harmful interference to radio or television reception, which can be determined by tuning the equipment on and off, the user is encouraged to try to correct the interference by one or more of the following measures:

- Reposition or relocate the receiving antenna.
- Increase the separation between the equipment and radio/TV receiver.
- Connect the equipment into an outlet on a circuit different from that to which the radio/TV is connected.
- Consult the dealer or an experienced radio/TV technician for assistance.

FCC CAUTION:

Pursuant to 47CFR, Part 15.21 of the FCC rules, any changes or modifications to this monitor not expressly approved by Matsushita Electric Corporation of America could cause harmful interference and would void the user's authority to operate this device.

To assure continued compliance, the shielded video cable with bonded ferrite cores provided must be used when connecting this TV to a computer device. (Part #TSX4515-3). The TDK EMI filter, also provided, Part #ANF-106U, must be used to plug this TV into a grounding type outlet.

CANADIAN NOTICE:

This class B digital apparatus meets all requirements of the Canadian Interference-Causing Equipment Regulations.

AVIS CANADIEN:

Cet appareil numérique de la classe B respecte toutes les exigences du règlement sur le matériel brouilleur du Canada.

Important: Changes or modifications not expressly approved by the party responsible for compliance could void the user's authority to operate the equipment.

FCC Declaration of Conformity

PANASONIC BROADCAST AND DIGITAL SYSTEMS COMPANY

Responsible party:
Division of Matsushita Electric Corporation of America
One Panasonic Way
Secaucus, NJ 07094
U.S.A.

Telephone Number: 1-800-524-1448
(9 a.m.-5 p.m., Mon-Fri, EST)
Email: PBTSSUPPORT@PANASONIC.COM
This device complies with Part 15 of the FCC rules. Operation is subject to the following two conditions:
(1) this device may not cause harmful interference, and (2) this device must accept any interference received, including interference that may cause undesired operation.

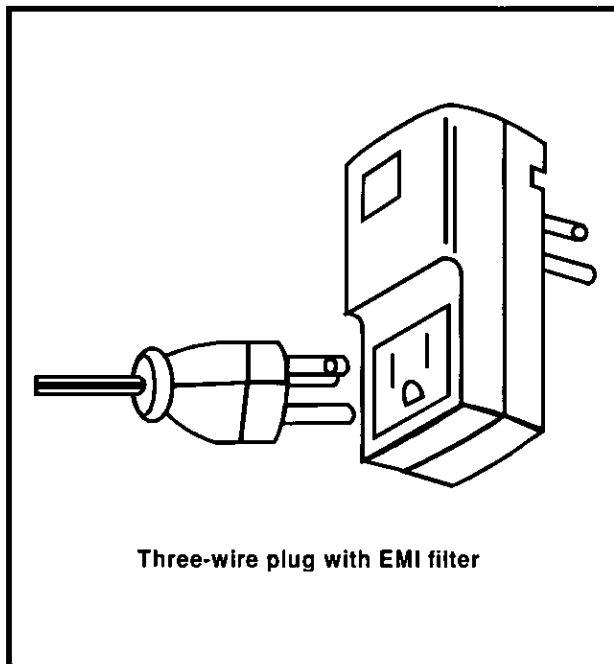

Congratulations

Your new color video monitor/receiver features a solid state chassis which is designed to give you many years of enjoyment. It was thoroughly tested and adjusted at the factory for best performance. To take full advantage of your new monitor/receiver, please read the following installation and operating instructions.

Customer Record

The model and serial number of this product are located on the back cover. You should note the model and serial number in the space provided and retain it as a permanent record of your purchase. This will aid in identification in the event of theft or loss. Product registration is available on-line at: www.prodreg.com\panasonic.

Model	
Number	
Serial	
Number	

Technical Assistance

- For Technical Assistance call 800-524-1448, Monday-Friday (9 a.m.-5 p.m. EST).
- For your local Service Center call 800-526-6610.
- Technical Support and Service Center information for your monitor is available on the Internet at www.panasonic.com or email at pbtssupport@panasonic.com.

Care and Cleaning

Picture Tube (Turn monitor/receiver OFF)

- Use a mild soap solution or window cleaner and a clean cloth.
- DO NOT USE ABRASIVE CLEANERS.
- Avoid excessive moisture and wipe dry.

Plastic Cabinet and Remote Control

- Use a soft cloth slightly moistened with water or a mild detergent solution and wipe dry with a soft clean cloth.
- Avoid excessive moisture.
- Do not use benzene, thinners or other petroleum-based cleaners.

For additional information about Panasonic products, visit our Internet site on the World Wide Web at: <http://www.panasonic.com>

SPECIFICATIONS

Specifications

Television Specifications	
Power Source	
CT-3697VY	120V AC, 60Hz
Channel Capability - 181	VHF - 12; UHF - 56; Cable - 125
2 Video Input Jacks	1V _{p-p} , 75 Ohms, phono jack type
4 Audio Input Jacks	500mV RMS, 47K Ohm
2 Audio Output Jacks (To Audio AMP)	0-2.0V RMS 4.7k Ohm
2 S-Video Output Jacks	S-Video (Y-C) Connector
3 DTV Input Jacks (Y, P_B, P_R)	75 Ohm, phono jack type
Stereo Sound	NTSC with DBX noise reduction
Surround Sound	Matrix

Computer Specifications	
PC and Mac Compatible	Yes
Viewable Image Size	36 inches
Dot Pitch	Data Grade
Multi-scan Rate	Yes
Horizontal Frequency Range	15 kHz to 38 kHz
Vertical Frequency Range	50 Hz to 120 Hz
Max. Data Resolution	800 x 600 @ 60 Hz
Linearity Correction	Automatic
S-Curve Correction	Yes
Dynamic Astigmatism and Focus Correction	Yes
Audio Input - computer	Mini-jack on front panel
Computer Input	2 Front and rear 15-pin connectors

Signal Capability Chart			
Signal	Format	Horiz. Freq.	Vert. Freq.
NTSC		15.75 kHz	60 Hz Interlaced
VGA	640 x 480	31.5 kHz	70 Hz
VGA text		31.5 kHz	70 Hz
VGA	640 x 480	31.5 kHz	60 Hz
SVGA	800 x 600	37.9 kHz	60 Hz
MAC2	640 x 480	35 kHz	66.6 Hz

Average Power Consumption			
TV Mode	VGA Mode	SVGA Mode	Standby Mode
180W	170W	175W	1.7W

Specifications are subject to change without notice or obligation.

Installation

Video Monitor/Receiver Location

This unit is intended to be used with an optional stand. Consult your dealer for available options.

- Avoid excessive sunlight or bright lights, including reflections.
- Keep away from excessive heat or moisture. Inadequate ventilation may cause internal component failure.
- Fluorescent lighting may reduce remote control transmitting range.
- Avoid magnetic equipment including motors, fans and external speakers.

Optional Cable Connections

Shielded audio and video cables should be used between components. For best results:

- Use 75 Ohm coaxial shielded cables.
- Use appropriate input and output connectors that match your component connectors.
- Avoid long cables to minimize interference.

Note: Two RCA to BNC adaptors are supplied with the monitor/receiver.



RCA to BNC Adaptor
(supplied)

Power Supply Cord

MAKE SURE THE PLUG IS INSERTED FULLY INTO THE EMI FILTER. SEE IMPORTANT INFORMATION SECTION FOR ILLUSTRATION.

This product is equipped with a three-wire grounding type plug; a plug with two blades and a round pin. This plug will only fit into a grounding type outlet. This is a safety feature. If you are unable to insert the plug into an outlet, contact an electrician to replace the obsolete outlet. **DO NOT DEFEAT THE SAFETY PURPOSE OF THE GROUNDING TYPE PLUG.**

TV Antenna/Cable Connection

For proper reception, an antenna or cable connection is required.

Antenna Connection

- For proper reception of VHF/UHF channels, an external antenna is required. For best reception, an outdoor antenna is recommended.
- In the Set Up menu, set MODE to TV. (Refer to the Mode section of the manual).

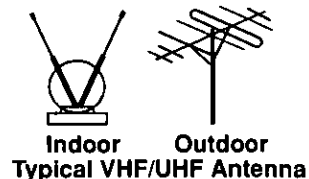

Incoming Cable from Home Antenna

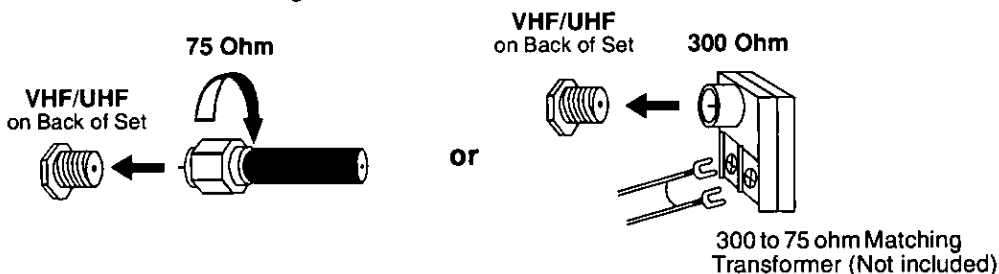

Cable Connection

- For reception of cable channels, connect the cable supplied by your local cable company.
- In the Set Up menu, set MODE to CABLE. (Refer to the Mode section of the manual).

Note: A cable converter box may be required for proper reception. Check with your local cable company for compatibility requirements.

Incoming Cable from Cable Company

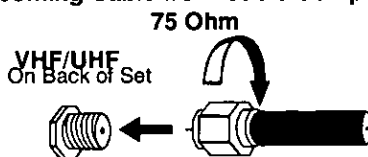

Cable Preset

Cable mode is preset at the factory. Antenna users must change the monitor/receiver to TV mode. (Refer to the Mode section of the manual).

Other Video Equipment

A second VCR, a video disc player, a computer, video game equipment or DSS equipment can also be connected to the antenna input connection.

Front Control Panel

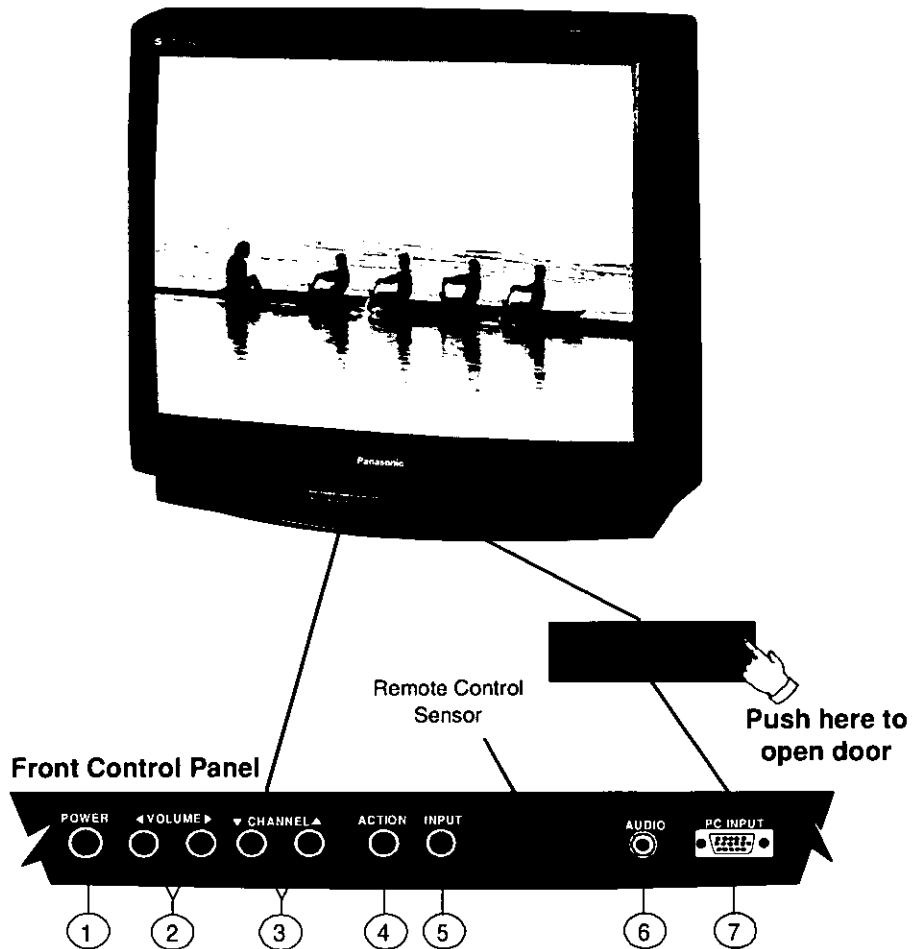

Quick Reference Front Control Panel Operation

- ① **Power Button** – Press to turn monitor/receiver ON or OFF.
- ② **Volume Buttons** – Press to adjust sound level, highlight icons and select or adjust options when menus are displayed.
- ③ **Channel Buttons** – Press to select programmed channels or to highlight icons and options when menus are displayed.
- ④ **Action Button** – Press to display Main Menu and to access or exit onscreen menus.
- ⑤ **Input Button** – In TV Mode, press to select TV or one of two video inputs. In PC Mode, press to select front or rear PC input.
- ⑥ **Audio Input** – Use front PC audio input jack when connected to a PC sound source audio output.
- ⑦ **PC Input** – Connect to a computer having a 15-pin output terminal.

Optional Equipment Connection and Operation

To Audio AMP Connection (Stereo)

To listen through a separate stereo system, connect an external audio amplifier TO AUDIO AMP terminals on back of monitor/receiver.

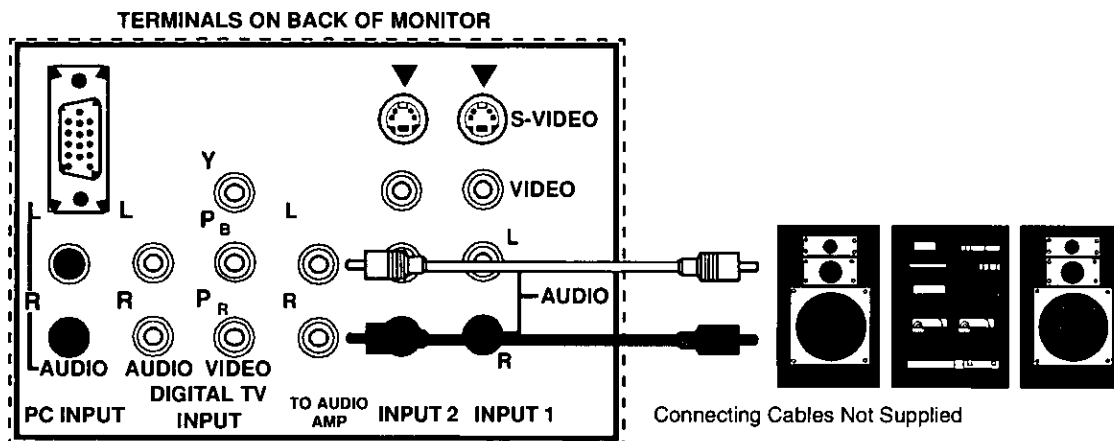

Note: TO AUDIO AMP terminals cannot be connected directly with external speakers.

Audio Adjustments

Procedure

1. Select TV SPEAKERS ON. (Refer to TV Speakers section of the manual).
2. Set amplifier volume to minimum.
3. Adjust monitor/receiver volume to desired level.
4. Adjust amplifier volume to match the monitor/receiver's volume.
5. Select TV SPEAKERS OFF&VAO. (Refer to TV SPEAKERS section of the manual).
6. Volume, mute, bass, treble and balance are now controlled through the monitor/receiver.

Note: Select TV SPEAKERS OFF&FAO to control audio functions through the external amplifier.

Audio/Video Connection

Follow the procedure below to connect your monitor to optional equipment (VCR, camcorder, etc.).

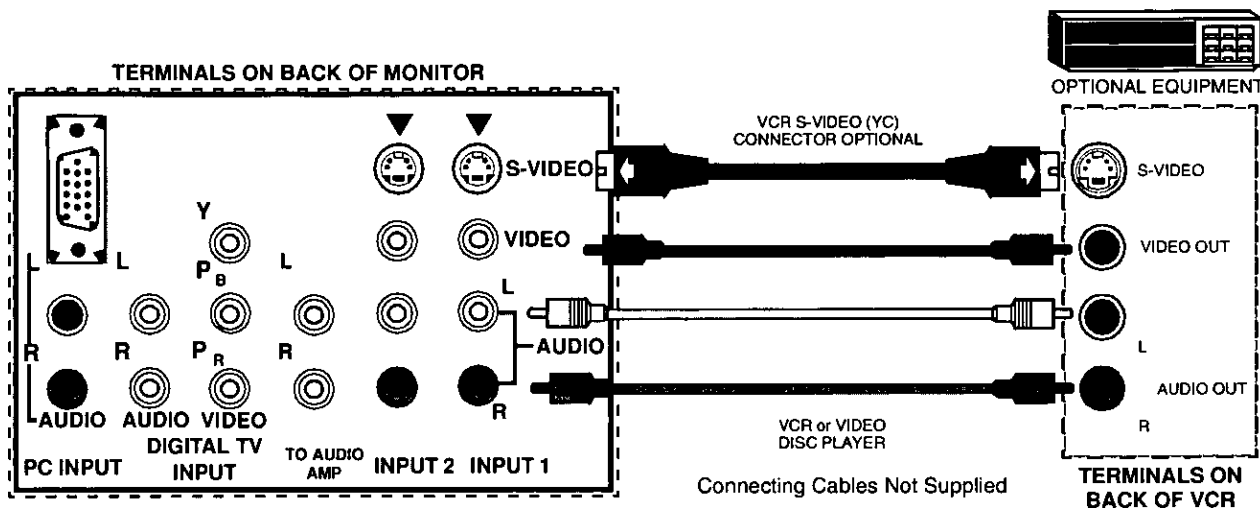

Note: The S-Video connection is optional and will override the standard Video connection.

Procedure

1. Connect the optional equipment, as shown, to INPUT 1 (or INPUT 2) terminals.
2. If S-Video is used, connect S-Video (YC) connector to S-Video terminal 1 (or 2) and connect audio cables to L and R Audio INPUT 1 (or INPUT 2) terminals.
3. Operate optional equipment as instructed in the manufacturer's operating manual.

Note: Select the proper VIDEO Input Mode where the equipment is connected by pressing the **INPUT** button on the monitor/receiver's remote control.

Trilingual Animated Icons

The icons allow the user to access menus to configure the monitor. It will also configure the monitor to operate with external components connected to the terminals on the back (or front) of the monitor.

TV Mode Icons

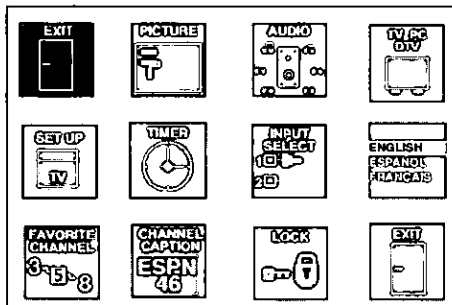

Note: Only the selected icon, which appears in red, will be animated.

Menu Navigation

- Use **CH** (channel) and **VOL** (volume) buttons to highlight icons.
 - Use **CH** (channel) buttons to highlight options within a submenu.
 - Use **VOL** (volume) buttons to select and adjust options within a submenu.



Menu Language Selection

The menu language is factory set to English. To change the menu language to Spanish or French, follow the procedure below.

Procedure

1. Press the **ACTION** button.
2. Press the **CH** and/or **VOL** buttons to highlight the Language (English, Español, Français) icon.
3. Press the **ACTION** button to display the Language menu.

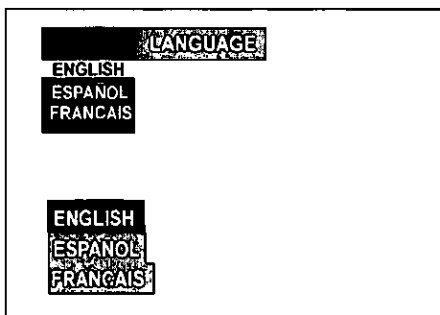

4. Press the **CH** buttons to select ENGLISH, ESPAÑOL or FRANÇAIS for the menu language.
5. Press the **ACTION** button twice to exit menus.



Picture Adjustments

Picture Norm

To reset the video adjustments to factory preset levels, follow the procedure below.

1. Press the **ACTION** button.
2. Press the **CH** and/or **VOL** buttons to highlight the Picture icon.
3. Press the **ACTION** button to display the Video menu.

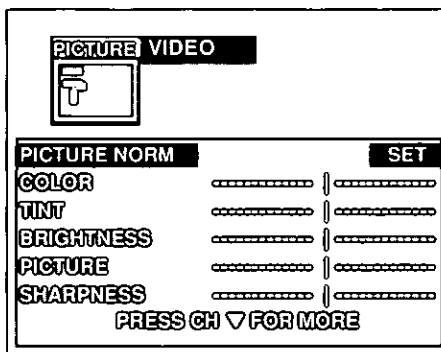

4. Press the **CH** buttons to highlight PICTURE NORM.
5. Press the **VOL** buttons to select SET to reset video adjustments to factory preset levels.
6. Press the **ACTION** button twice to exit menus.

Video Adjustments

The video adjustments are factory set to certain levels. To change the preset levels, follow the procedure below.

Procedure

1. Press the **ACTION** button.
2. Press the **CH** and/or **VOL** buttons to highlight the Picture icon.
3. Press the **ACTION** button to display the Video menu.

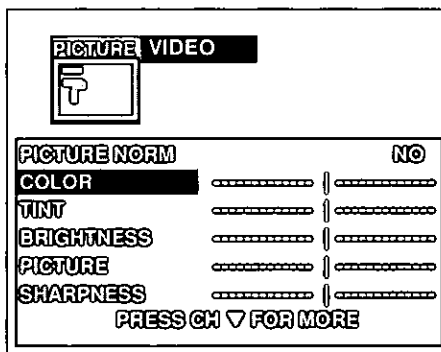

Picture Adjustments (cont.)

4. Press the **CH** buttons to highlight a video adjustment.
 - Color - adjust for color intensity
 - Tint - adjust for natural flesh tones
 - Brightness - adjust dark areas for crisp detail
 - Picture - adjust white areas of the picture
 - Sharpness - adjust clarity of outline detail
5. Press the **VOL** buttons to adjust the setting.
6. Press the **ACTION** button twice to exit menus.

Other Adjustments

To change the color temp (temperature), set auto color, or change the video NR (noise reduction), follow the procedures below.

Color Temp

This option changes the color temperature.

Procedure

1. Press the **ACTION** button.
2. Press the **CH** and/or **VOL** buttons to highlight the Picture icon.
3. Press the **ACTION** button to display the Video menu.
4. Press the **CH**  button to display more adjustment options.

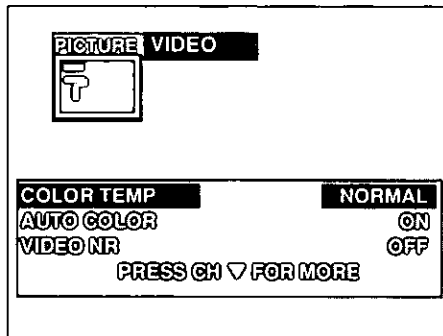

5. Press the **CH** buttons to highlight **COLOR TEMP**.
6. Press the **VOL** buttons to change the color temperature.
 - Normal - no tint
 - Warm - reddish tint
 - Cool - bluish tint
7. Press the **ACTION** button repeatedly to exit menus.

Picture Adjustments (cont.)

Auto Color

This option optimizes color adjustment to compensate for signal variations.

Procedure

1. Press the **ACTION** button.
2. Press the **CH** and/or **VOL** buttons to highlight the Picture icon.
3. Press the **ACTION** button to display the Video menu.
4. Press the **CH**  button to display more adjustment options.

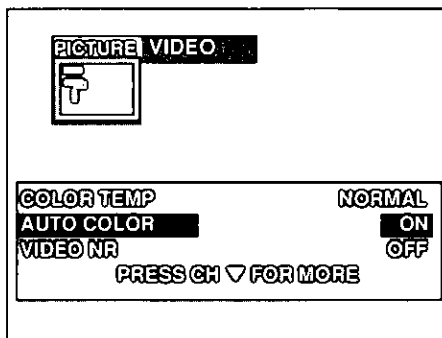

5. Press the **CH** buttons to highlight AUTO COLOR.
6. Press the **VOL** buttons to select ON or OFF.
7. Press the **ACTION** button repeatedly to exit menus.

Video NR (Noise Reduction)

This option increases the horizontal resolution of the picture.

Procedure

1. Press the **ACTION** button.
2. Press the **CH** and/or **VOL** buttons to highlight the Picture icon.
3. Press the **ACTION** button to display the Video menu.
4. Press the **CH**  button to display more adjustment options.

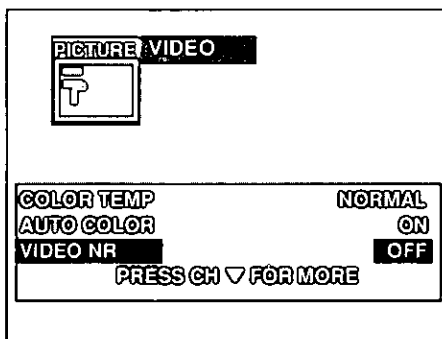

5. Press the **CH** buttons to highlight VIDEO NR (noise reduction).
6. Press the **VOL** buttons to select ON or OFF.
7. Press the **ACTION** button repeatedly to exit menus.



Audio Adjustments

Audio Norm

To reset the audio adjustments to factory preset levels, follow the procedure below.

Procedure

1. Press the **ACTION** button.
2. Press the **CH** and/or **VOL** buttons to highlight the Audio icon.
3. Press the **ACTION** button to display the Audio menu.

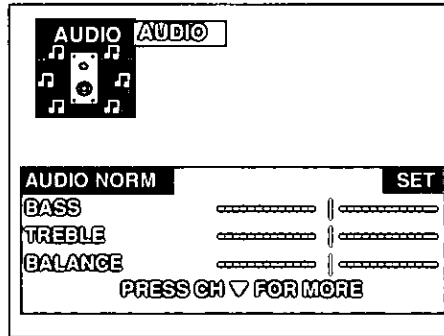

4. Press the **CH** buttons to highlight **AUDIO NORM**.
5. Press the **VOL** buttons to select **SET** to reset audio adjustments to factory preset levels.
6. Press the **ACTION** button twice to exit menus.

Audio Adjustments

The audio adjustments are factory set to certain levels. To change the preset levels, follow the procedure below.

Procedure

1. Press the **ACTION** button.
2. Press the **CH** and/or **VOL** buttons to highlight the Audio icon.
3. Press the **ACTION** button to display the Audio menu.

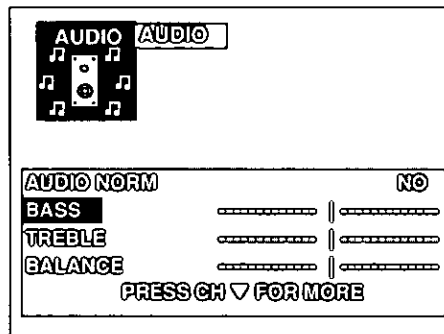

Audio Adjustments (cont.)

4. Press the **CH** buttons to highlight an audio adjustment.
 - Bass - increase or decrease the bass response
 - Treble - increase or decrease the treble response
 - Balance - emphasize the right /left speaker volume.
5. Press the **VOL** buttons to adjust the setting.
6. Press the **ACTION** button twice to exit the menus.

Other Adjustments

To change modes (Stereo, SAP or Mono) or activate/deactivate internal speakers, surround sound or AI sound, follow the procedures below.

Mode (Stereo/SAP/Mono)

This option changes the audio mode. An onscreen display showing the three modes (Stereo, SAP and Mono) will appear when the monitor/receiver is turned ON and when the channel is changed. The available choices will appear in red.

Procedure

1. Press the **ACTION** button.
2. Press the **CH** and/or **VOL** buttons to highlight the Audio icon.
3. Press the **ACTION** button to display the Audio menu.
4. Press the **CH**  button to display more adjustment options.

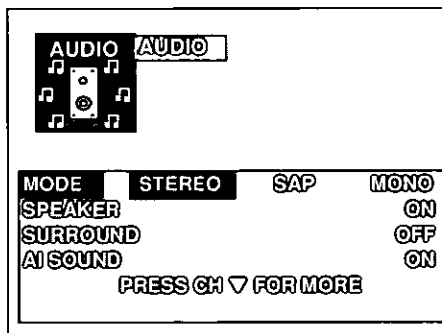

5. Press the **CH** buttons to highlight **MODE**.
6. Press the **VOL** buttons to select a mode.
 - Stereo - for two channel audio reception
 - SAP - for second audio programming (bilingual audio, weather reports, etc.)
 - Mono - to use when signal is weak
7. Press the **ACTION** button twice to exit menus.

Speaker

This option turns the internal monitor/receiver speakers ON or OFF when the monitor/receiver is connected to an external audio amplifier. (Refer to To Audio Amp section of the manual).

Procedure

1. Press the **ACTION** button.
2. Press the **CH** and/or **VOL** buttons to highlight the Audio icon.
3. Press the **ACTION** button to display the Audio menu.

Audio Adjustments (cont.)

4. Press the **CH**  button to display more adjustment options.

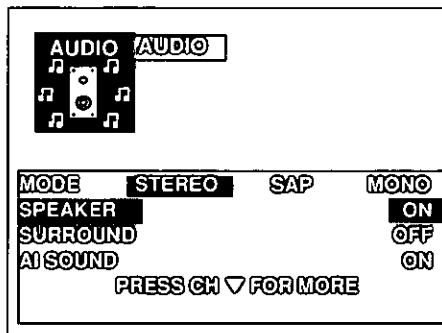

5. Press the **CH** buttons to highlight **SPEAKER**.
6. Press the **VOL** buttons to turn the speakers **ON** or **OFF**.
 - On - monitor/receiver speakers operate normally
 - Off&VAO (variable audio out) - monitor/receiver speakers are OFF and the audio is adjusted through the monitor/receiver
 - Off&FAO (fixed audio out) - monitor/receiver speakers are OFF and audio is adjusted through the external amplifier
7. Press the **ACTION** button twice to exit menus.

Surround

This option turns the surround sound feature **ON** or **OFF**. Surround sound enhances the audio response when listening to stereo broadcasts.

Procedure

1. Press the **ACTION** button.
2. Press the **CH** and/or **VOL** buttons to highlight the Audio icon.
3. Press the **ACTION** button to display the Audio menu.
4. Press the **CH**  button to display more adjustment options.

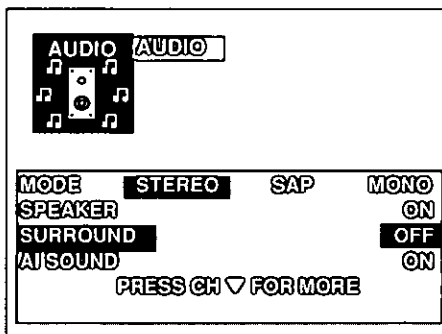

5. Press the **CH** buttons to highlight **SURROUND**.
6. Press the **VOL** buttons to select **ON** or **OFF**.
7. Press the **ACTION** button twice to exit menus.

Audio Adjustments (cont.)

AI Sound

This option allows the monitor/receiver to maintain a constant sound level between programs with different sound levels.

Procedure

1. Press the **ACTION** button.
2. Press the **CH** and/or **VOL** buttons to highlight the Audio icon.
3. Press the **ACTION** button to display the Audio menu.
4. Press the **CH**  button to display more adjustment options.

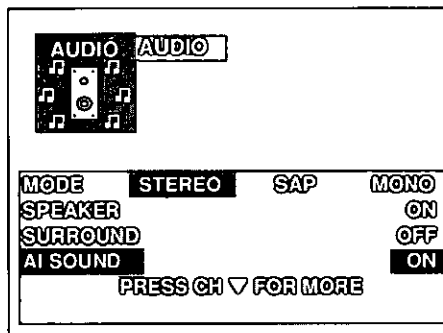

5. Press the **CH** buttons to highlight AI SOUND.
6. Press the **VOL** buttons to select ON or OFF.
7. Press the **ACTION** button twice to exit menus.



TV/PC/DTV Mode

The monitor/receiver can be set to three (TV, PC or DTV) different modes. To select a mode, follow the procedure below.

Procedure

1. Press the **ACTION** button.
2. Press the **CH** and/or **VOL** buttons to highlight the TV/PC/DTV icon.
3. Press the **ACTION** button to display the TV/PC/DTV mode menu.

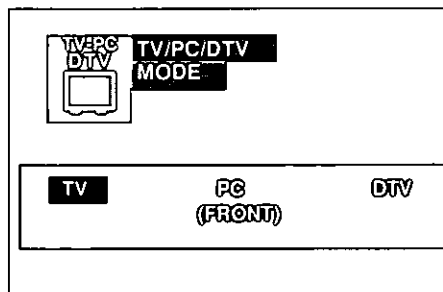

TV/PC/DTV Mode (cont.)

4. Press the **VOL** buttons to select a mode.
 - TV - television mode
 - PC - computer mode

Note: Press the **INPUT** button to select front or rear PC inputs.

 - DTV - digital television mode
5. Press the **ACTION** button twice to exit menus.

Set Up Options



Clock

The clock will appear onscreen when the monitor/receiver is turned ON, the channel is changed or when the **RECALL** button is pressed on the monitor/receiver remote control. The clock must be set to use the dual timer option.

Auto Clock

This option automatically adjusts the monitor/receiver clock to the correct time when the monitor/receiver is tuned to a PBS (Public Broadcasting Service) station for 10 minutes or until the correct time and day are displayed. (Refer to your local TV guide for the PBS channel).

Note: A plus or minus one-hour offset can be programmed to adjust the clock if there is a time zone difference between the PBS television station and the viewer.

Procedure

1. Press the **ACTION** button.
2. Press the **CH** and/or **VOL** buttons to highlight the Set Up icon.
3. Press the **ACTION** button to display the Set Up menu.

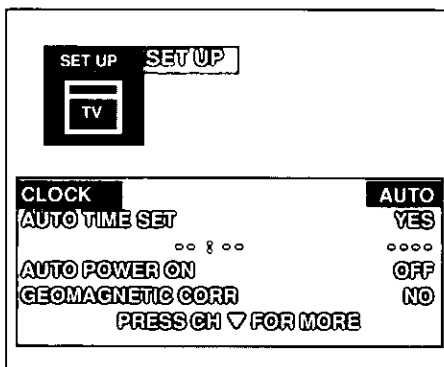



Note: This menu is not available when **AUTO POWER ON** is set.

4. Press the **CH** buttons to highlight **CLOCK**.
5. Press the **VOL** buttons to select **AUTO**.

Set Up Options (cont.)

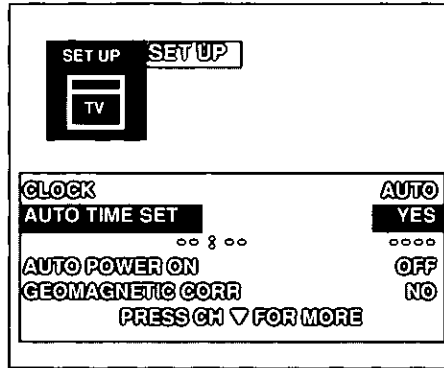
6. Press the CH  button to highlight AUTO TIME SET.



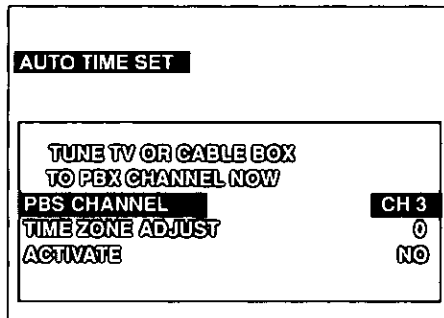

7. Press the VOL buttons to select YES and display the Auto Time Set menu.
8. Press the CH  button to highlight PBS CHANNEL.

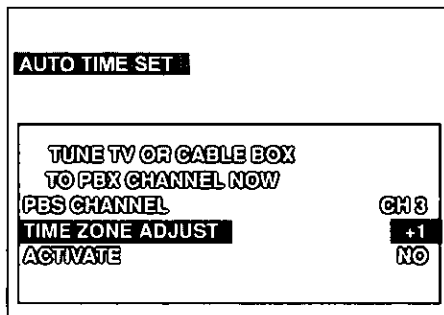

9. Tune the monitor/receiver or cable box, using the remote control numeric keypad, to the PBS channel.
10. Press the CH  button to highlight TIME ZONE ADJUST.



11. Press the VOL  button for a minus one-hour offset or VOL  button for a plus one-hour offset.

Set Up Options (cont.)

12. Press the **CH**  button to highlight **ACTIVATE**.

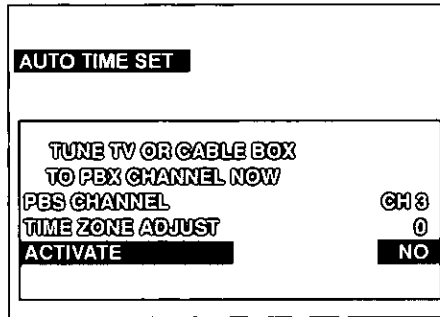

13. Press the **VOL** buttons to select **YES** and display the Activate menu.

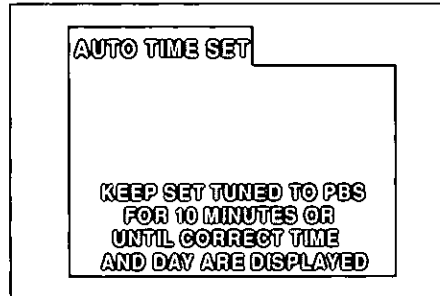

Menu displayed while time and day are being set

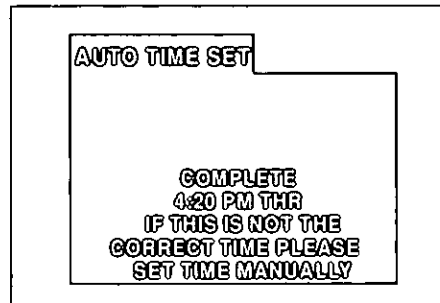

Menu displayed when time and day are set

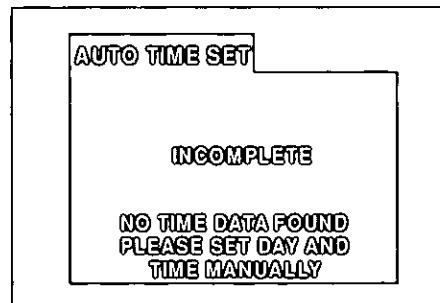

Menu displayed if automatic procedure fails

14. Press the **ACTION** button repeatedly to exit menus.

Set Up Options (cont.)

Manual Clock

This option allows the clock to be manually set.

Procedure

1. Press the **ACTION** button.
2. Press the **CH** buttons and/or **VOL** buttons to highlight the Set Up icon.
3. Press the **ACTION** button to display the Set Up menu.

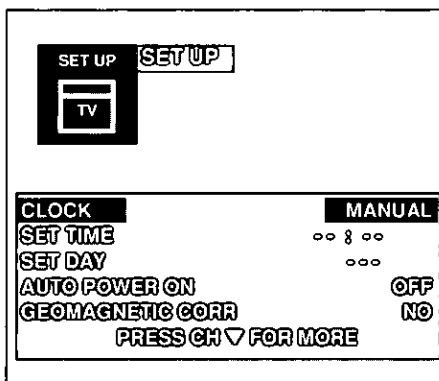

4. Press the **CH** buttons to highlight **CLOCK**.
5. Press the **VOL** buttons to select **MANUAL**.
6. Press the **CH** buttons to highlight **SET TIME**.

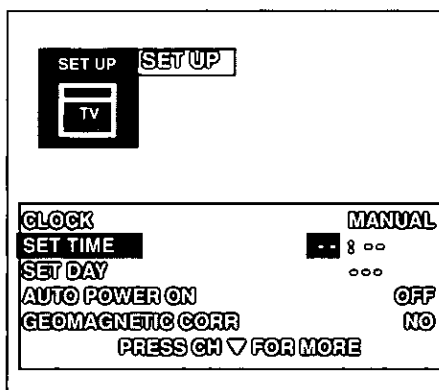

7. Press the **VOL** buttons to set the hour.
8. Press the **CH**  button to highlight the minutes.
9. Press the **VOL** buttons to set the minutes.
10. Press the **ACTION** button twice to exit menus.

Set Up Options (cont.)

Set Day

This option allows the day to be set. This option must be set to operate the dual timer option.

Procedure

1. Press the **ACTION** button.
2. Press the **CH** buttons and/or the **VOL** buttons to highlight the Set Up icon.
3. Press the **ACTION** button to display the Set Up menu.

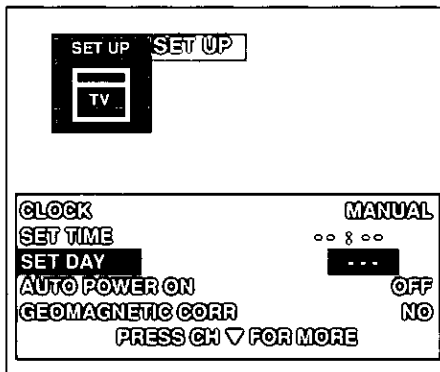

4. Press the **CH** buttons to highlight SET DAY.
5. Press the **VOL** buttons to select the day of the week.
6. Press the **ACTION** button twice to exit menus.

Auto Power On

This option allows the monitor/receiver to turn ON simultaneously with a VCR, cable box, etc. The monitor must be plugged into the switched outlet of the device. Activating the Auto Power On option will cancel the time and timer control settings.

Note: The *TIMER CONTROL* icon will be replaced with an *EXIT* icon in the Main Menu.

Procedure

1. Press the **ACTION** button.
2. Press the **CH** and/or **VOL** buttons to highlight the Set Up icon.
3. Press the **ACTION** button to display the Set Up menu.

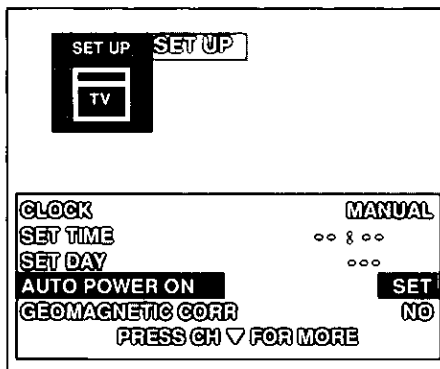

Set Up Options (cont.)

4. Press the **CH** buttons to highlight AUTO POWER ON.
5. Press the **VOL** buttons to select SET or OFF.
6. Press the **ACTION** button twice to exit menus.

Geomagnetic Corr (Correction)

This monitor has a special adjustment option that compensates for the earth's geomagnetic field. Although the adjustment is preset at the factory, a correction may be needed if the monitor is moved.

Procedure

1. Press the **ACTION** button.
2. Press the **CH** and/or **VOL** buttons to highlight the Set Up icon.
3. Press the **ACTION** button to display the Set Up menu.

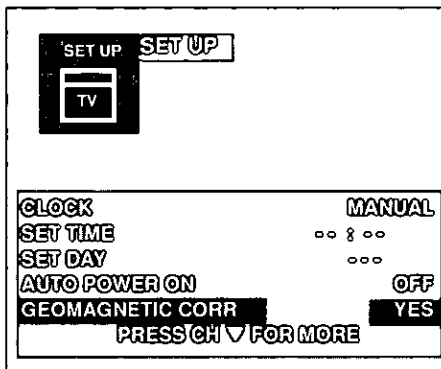

4. Press the **CH** buttons to highlight GEOMETRIC CORR.
5. Press the **VOL** buttons to select YES and display the tilt adjustment bar menu.

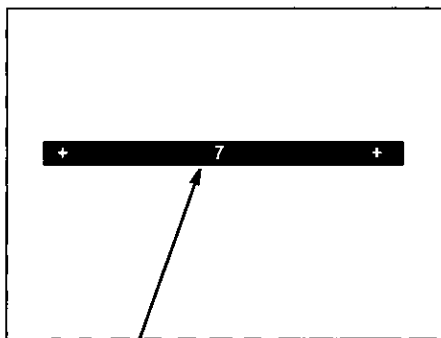

tilt adjustment bar

6. Press the **VOL** buttons to adjust the tilt adjustment bar until it is parallel to the bottom of the picture frame.

Note: *Discoloration may be visible in the picture corners if the tilt adjustment bar is not parallel to the bottom of the picture frame.*

7. Press the **ACTION** button twice to exit menus.

Set Up Options (cont.)

Mode

This option allows either TV (antenna) or cable mode to be selected depending on the signal source.

Procedure

1. Press the **ACTION** button.
2. Press the **CH** and/or **VOL** buttons to highlight the Set Up icon.
3. Press the **ACTION** button to display the Set Up menu.
4. Press the **CH**  button to display more set up options.

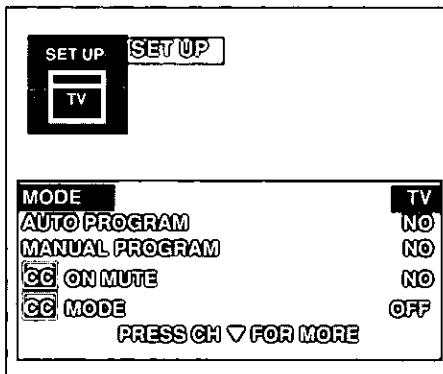

5. Press the **CH** buttons to highlight MODE.
6. Press the **VOL** buttons to select TV or CABLE.
7. Press the **ACTION** button twice to exit menus.

Auto Program

This option will automatically scan all channels and store the ones with a video signal into the channel scan memory. After the auto programming scan is complete, up to fifteen channels will be stored into the Favorite Channel Select Memory (if space is available). Any channels already stored in the Favorite Channel Select Memory will remain. (Refer to the Favorite Channel section of the manual).

Note: Channels with a very weak video signal may be stored into memory. These channels must be deleted using the Manual Program option.

Procedure

1. Press the **ACTION** button.
2. Press the **CH** and/or **VOL** buttons to highlight the Set Up icon.
3. Press the **ACTION** button to display the Set Up menu.

Set Up Options (cont.)

- Press the **CH**  button to display more set up options.

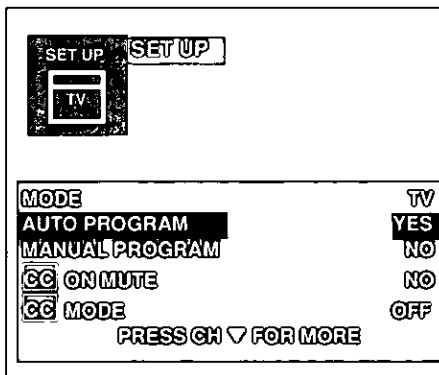

- Press the **CH** buttons to highlight **AUTO PROGRAM**.
- Press the **VOL** buttons to begin the auto programming scan.
Note: Channels stored in the Channel Scan Memory will turn blue.
- Press the **ACTION** button twice to exit menus.

Manual Program

This option allows channels to be manually stored or deleted from the Channel Scan Memory.

Procedure

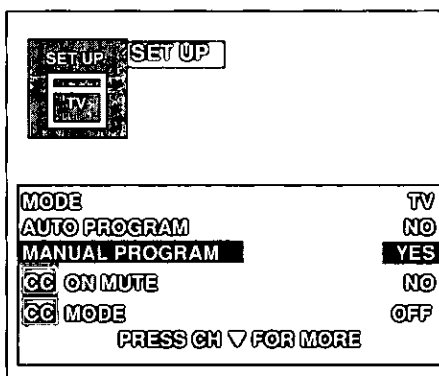

- Press the **ACTION** button.
- Press the **CH** and/or **VOL** buttons to highlight the Set Up icon.
- Press the **ACTION** button to display the Set Up menu.
- Press the **CH**  button to display more set up options.

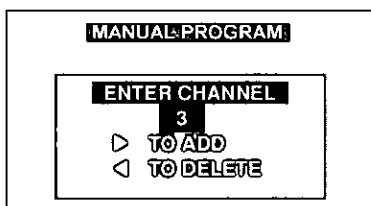

- Press the **CH** buttons to highlight **MANUAL PROGRAM**.
- Press the **VOL** buttons to display the Manual Programming menu.



Set Up Options (cont.)

7. Use the numeric keypad on the remote control or the **CH** buttons to select channels.
8. Press the **VOL**  button to add a channel and the **VOL**  button to delete a channel from Channel Scan Memory.
Note: The added channel will turn blue while the deleted channel will turn yellow.
9. Repeat steps 7 and 8 to add and delete channels.
10. Press the **ACTION** button twice to exit menus.

CC on Mute

This option activates Closed Captioning when the **MUTE** button on the remote control is pressed. The program being viewed must be broadcast with Closed Captioning for this option to work. (Refer to your local TV guide for information).

Note: **CC** Mode must be OFF for the option to operate.

Procedure

1. Press the **ACTION** button.
2. Press the **CH** and/or **VOL** buttons to highlight the Set Up icon.
3. Press the **ACTION** button to display the Set Up menu.
4. Press the **CH**  button to display more set up options.

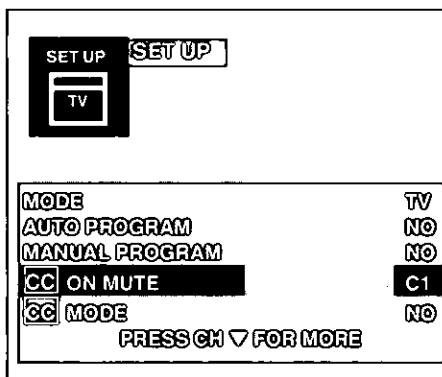

5. Press the **CH** buttons to highlight **CC** ON MUTE.
6. Press the **VOL** buttons to select a closed captioning mode.
 - No - closed captioning is deactivated.
 - C1 - for video related information to be displayed, up to four lines onscreen at a time. (it does not block relevant parts of the picture).
 - C2 to C4 - for other modes of video related information.

Note: Recommended set up for **CC** on Mute.

- **CC** on Mute: C1
- **CC** Mode: OFF

7. Press the **ACTION** button twice to exit menus.
8. Press the **MUTE** button on the remote control to activate the option. Press the **MUTE** button again to deactivate.

Lock



V-Chip Parental Lock

The V-Chip allows parents to block, at their discretion, various types of movies, videos, video games and television programs.

Lock Mode

Select Lock Mode to prevent video games and video tapes from being viewed.

Procedure

1. Press the **ACTION** button.
2. Press the **CH** and/or **VOL** buttons to highlight the Lock icon.
3. Press the **ACTION** button to display the Lock menu.

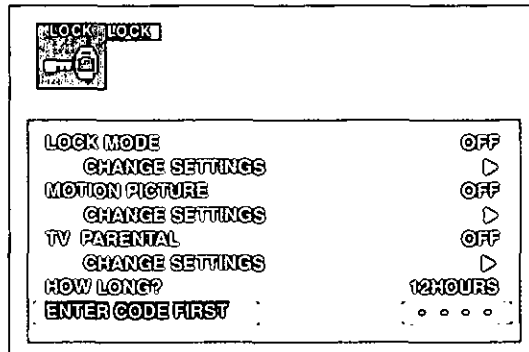

4. Use the numeric keypad to enter a four-digit secret code. (Use a code that is easy to remember and record it in a safe place.)

Note: After entering your secret code for the first time, the on screen display will change to Change Code.

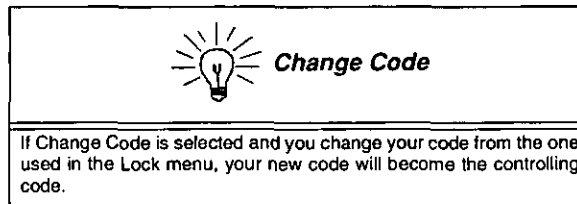

Set Up Options (cont.)

CC Mode

This monitor/receiver contains a built-in decoder that displays **CC** (Closed Captioned) text across the screen (white or colored letters on a black background). It allows the viewer to read the dialogue of a television program or other information. The program viewed must include closed captioning for the option to work.

Procedure

1. Press the **ACTION** button.
2. Press the **CH** and/or **VOL** buttons to highlight the Set Up icon.
3. Press the **ACTION** button to display the Set Up menu.
4. Press the **CH**  button to display more set up options.

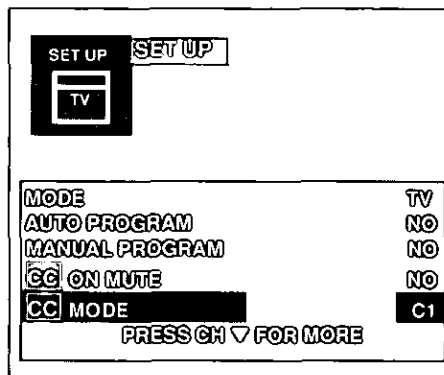

5. Press the **CH** buttons to highlight **CC** MODE.
6. Press the **VOL** buttons to select a closed captioning mode.
 - Off - closed captioning is deactivated.
 - C1 - for video related information to be displayed, up to four lines onscreen at a time. (it does not block relevant parts of the picture).
 - C2 to C4 - for other modes of video related information.
 - T1 - for program guide and other information to be displayed, when available. (Blocks a large portion of the picture on the monitor/receiver screen).
 - T2 to T4 - for other modes of information. (Blocks a large portion of the picture on the monitor/receiver screen).
7. Press the **ACTION** button twice to exit menus.

Lock (cont.)

9. Press the **CH**  button to highlight HOW LONG?.

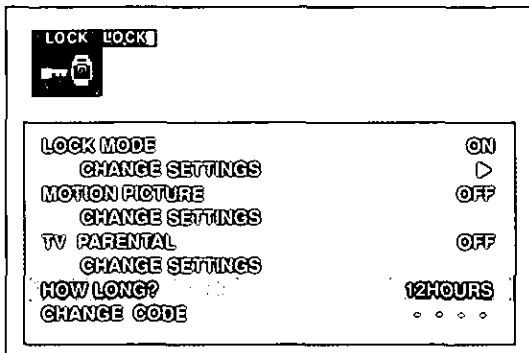

10. Press the **VOL** buttons to select 12, 24, 48 hours or Always.
11. Press the **ACTION** button twice to exit menus.

To unlock Lock Mode, repeat steps 1 through 4, then select OFF.



Unlocking

If you do not remember your four-digit secret code, the Lock Mode will automatically unlock in 12, 24, or 48 hours, depending on the time period selected during setup. Be cautious when selecting Always because if you forget your secret code, the television must be serviced by a qualified technician to clear the setup.

Motion Picture

This option allows parents to block various types of movies and video tapes based on motion picture ratings (PG, R, etc.).

Procedure

1. Press the **ACTION** button.
2. Press the **CH** and/or **VOL** buttons to highlight the Lock icon.
3. Press the **ACTION** button to display the Lock menu.

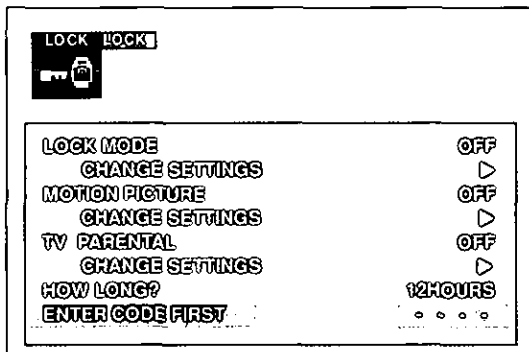

4. Use the numeric keypad to enter your four-digit secret code. (Use a code that is easy to remember and record it in a safe place.)

Lock (cont.)

5. Press the VOL buttons to select ON or OFF.

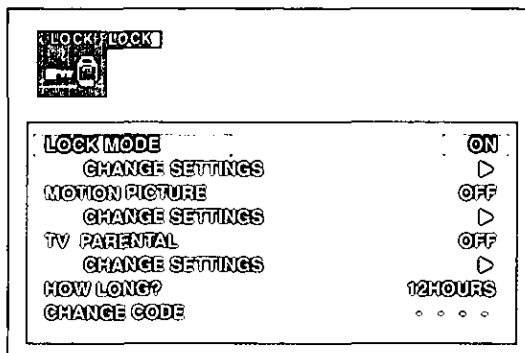

6. Press the CH  button to highlight CHANGE SETTINGS.

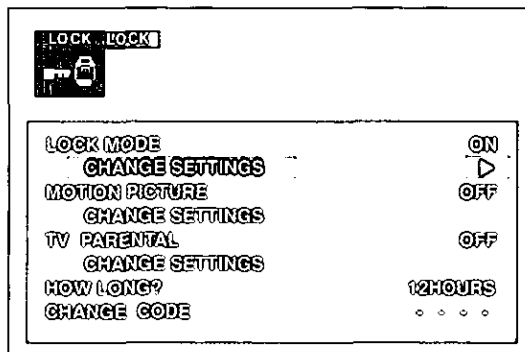

7. Press the VOL buttons to select a lock mode.
- Game - locks Ch 3, 4 and all video inputs
 - Channel - locks up to four channels of your choice
 - Use the numeric keypad or VOL buttons to select a channel
 - Use the CH  button to select the next channel position.
 - All - locks all channels and video inputs

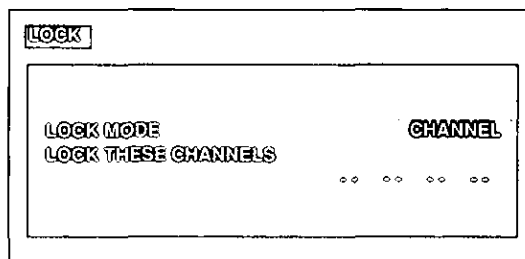



Note: If Game, Channel or All is selected, and if a blocked channel or video input is selected, the message PG (Parent Guard) displays in the upper right corner of the television screen.

8. Press the ACTION button to return to the Lock menu.

Lock (cont.)

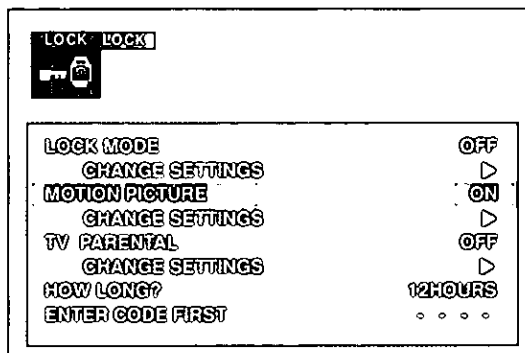
5. Press the **CH** buttons to highlight MOTION PICTURE.



6. Press the **VOL** buttons to select ON or OFF.
 7. Press the **CH**  button to highlight CHANGE SETTINGS.

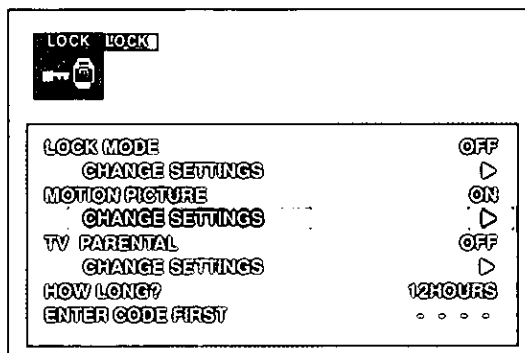

8. Press the **VOL** buttons to display the Motion Picture Rating menu.

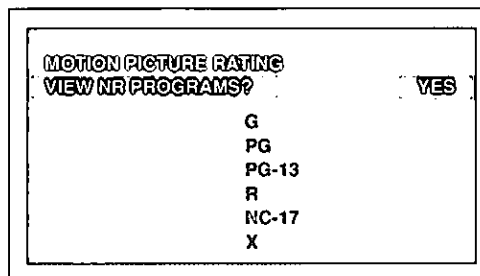

9. Press the **VOL** buttons to select YES or NO.

Note: Movies are Not Rated (NR) for a variety of reasons (old movies and foreign movies usually have no ratings).

10. Press the **CH**  button to highlight the motion picture ratings.

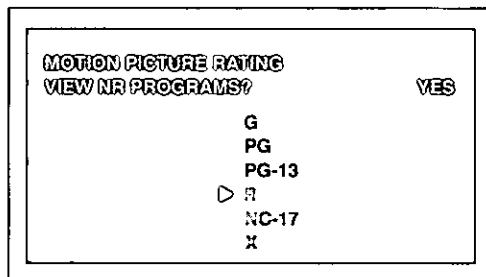

R, NC-17 and X will be blocked

11. Press the **CH** buttons to move between different ratings. Use the **VOL** buttons to select the ratings you want to block (red) and unblock (green).

Note: See the Motion Picture Ratings chart.

MOTION PICTURE RATINGS CHART

NR	Contains no rating. Not Rated (NR) and Not Applicable (NA) programs have not been rated or ratings do not apply.
G	General audiences. All ages admitted.
PG	Parental guidance suggested. Some material may not be suitable for children.
PG-13	Parents strongly cautioned. Some material may be inappropriate for children under 13.
R	Restricted. Under 17 requires accompanying parent or adult guardian.
NC-17	No one 17 and under admitted.
X	Adults only.

12. Press the **ACTION** button to return to the Lock menu.
 13. Press the **CH**  button to highlight HOW LONG?.

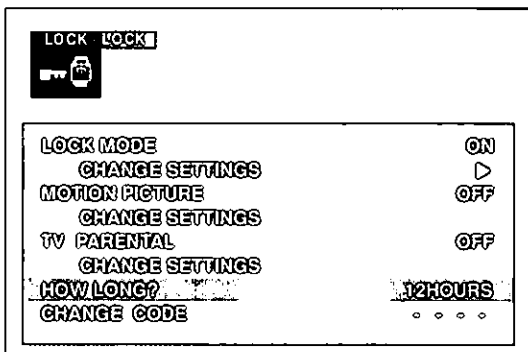

14. Press the **VOL** buttons to select 12, 24, 48 hours or Always.

15. Press the **ACTION** button repeatedly to exit menus.

To disable Motion Picture, repeat steps 1 through 5, then select OFF.

Lock (cont.)

TV Parental

This option allows parents to block various types of television programming based on parental guide ratings (TV-Y, TV-PG, etc.).

Procedure

1. Press the **ACTION** button.
2. Press the **CH** and/or **VOL** buttons to highlight the Lock icon.
3. Use the numeric keypad to enter your four-digit secret code. (Use a code that is easy to remember and record it in a safe place.)

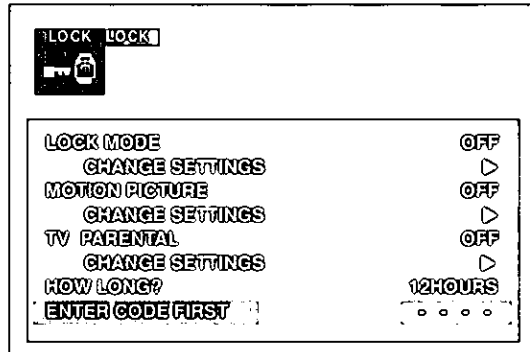

4. Press the **CH** buttons to highlight TV PARENTAL.

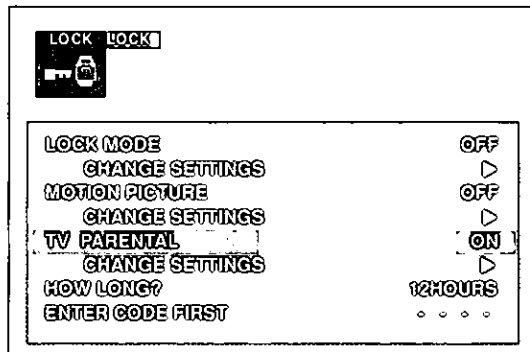

5. Press the **VOL** buttons to select ON or OFF.

6. Press the CH  button to highlight CHANGE SETTINGS.

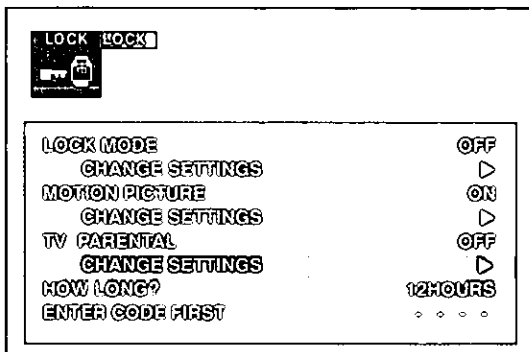

7. Press the VOL buttons to display the TV Parental Guide menu.

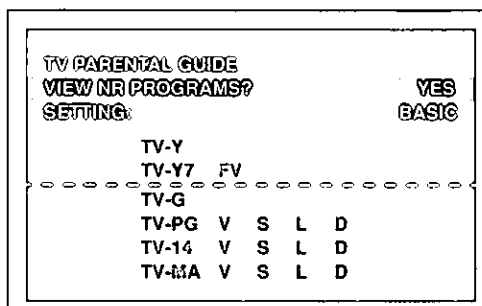

8. Press the VOL buttons to select YES or NO.

Note: Selecting YES means NR (Not Rated) programs will be received. Selecting NO means NR programs will be blocked. (See Customer Caution for more information).

9. Press the CH  button to highlight SETTING.

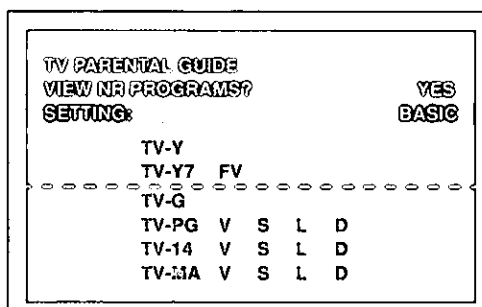

10. Press the VOL buttons to select BASIC or DETAILED.

- Basic - allows only general ratings to be selected (TV-Y, TV-PG, etc.)
- Detailed - allows both general ratings and content such as V, L, etc. to be selected

Lock (cont.)

11. Press the **CH**  button to highlight the TV parental guide ratings.

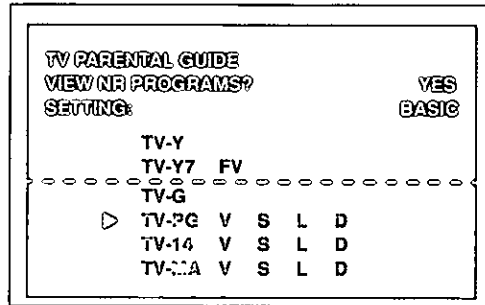

12. Press the **CH** buttons to move between different ratings. Use the **VOL** buttons to select the ratings you want to block (red) and unblock (green).

Note: See the TV Parental Guide Ratings chart.



Customer Caution

The V-Chip system used in this television is capable of blocking NR (Not Rated, Not Applicable and None) programs per FCC Rules section 15.120(e)(2). If the option of blocking NR programs is selected "unexpected and possibly confusing results may occur, and you may not receive emergency bulletins or any of the following types of programming."

- Emergency bulletins (EAS, messages, weather warnings, etc.)
- Locally originated programs
- News
- Political
- Public service announcements
- Religious
- Sports
- Weather

TV PARENTAL GUIDE RATINGS CHART

NR	Not Rated. See Customer Caution.
TV-Y	All children. This program is specifically designed for a very young audience, including children from ages 2 through 6.
TV-Y7	Directed to older children. This program may include mild physical or comedic violence, or may frighten children under the age of 7.
TV-G	General audience. This program contains little or no violence, no strong language and little or no sexual dialogue or situations.
TV-PG	Parental guidance suggested. This program may contain infrequent coarse language, limited violence and some suggestive sexual dialogue and situations.
TV-14	Parents strongly cautioned. This program may contain sophisticated themes, sexual content, strong language and intense violence.
TV-MA	Mature audiences only. This program may contain mature themes, profane language, graphic violence and explicit sexual content.
FV	Fantasy/cartoon violence
V	Violence
S	Sex
L	Offensive language
D	Dialogue with sexual content

13. Press the **ACTION** button to return to the Lock menu.
14. Press the **CH**  button to highlight HOW LONG?.

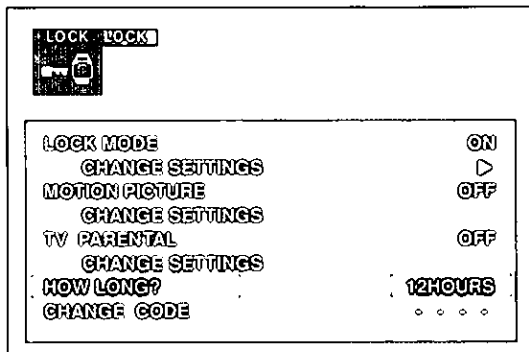

15. Press the **VOL** buttons to select 12, 24, 48 hours or Always.
 16. Press the **ACTION** button repeatedly to exit menus.
- To disable TV Parental, repeat steps 1 through 5, then select OFF.

Lock (cont.)**Blocking Message**

If the V-Chip options are activated and the program exceeds the rating limit set by the user, a blocking message will appear and the audio will be muted. Enter your four-digit secret code to continue viewing the program. All V-Chip settings will be temporarily overridden until they are reprogrammed or until the television is turned off.

Note: *The V-Chip settings will be reactivated when the television is turned on again.*

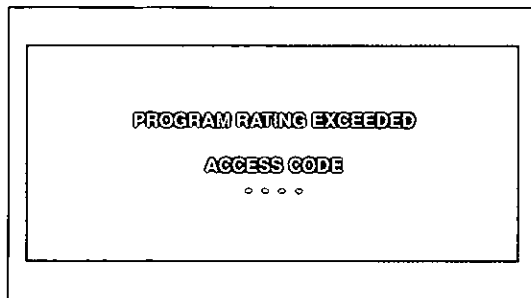

Timer Options



Sleep Timer

This option, if set, will automatically turn the monitor/receiver OFF in 30, 60 or 90 minutes. It is not available when Auto Power On is used.

Note: The onscreen display will flash the last three minutes (3, 2, and 1) prior to turning OFF.

Procedure

1. Press the **ACTION** button.
2. Press the **CH** and/or **VOL** buttons to highlight the Timer icon.
3. Press the **ACTION** button to display the Timer Control menu.

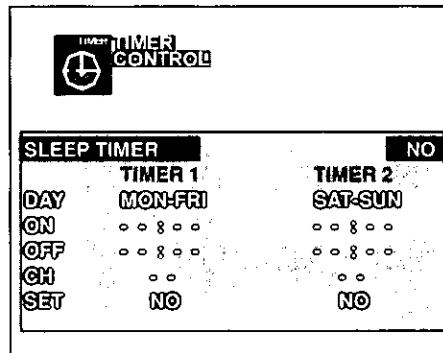

4. Press the **CH** buttons to highlight SLEEP TIMER.
5. Press the **VOL** buttons to select the amount of time before the monitor/receiver turns OFF.
 - No - to deactivate the sleep timer
 - 30 (minutes)
 - 60 (minutes)
 - 90 (minutes)
6. Press the **ACTION** button twice to exit menus.

Note: The timers (1 and 2) will override the Sleep Timer setting.

Timer Options (cont.)

Timer 1 and Timer 2

This option allows the monitor/receiver to be programmed to turn ON to a specific channel at a certain time and to turn OFF at a predetermined time. The timers (1 and 2) will override the Sleep Timer setting. This option is not available when Auto Power On is used.

Note: The time and day must be set before this option can be used. (Refer to the Set Up Options section of the manual).

Procedure

1. Press the **ACTION** button.
2. Press the **CH** and/or **VOL** buttons to highlight the Timer icon.
3. Press the **ACTION** button to display the Timer Control menu.

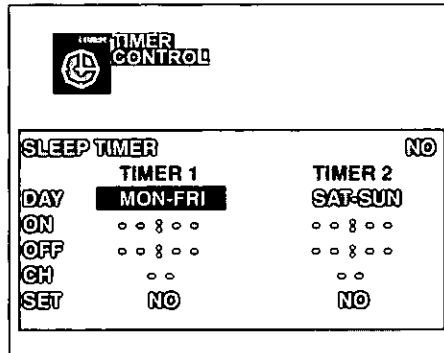

4. Press the **CH** buttons to highlight the first line (Day) under either Timer 1 or Timer 2.
 5. Press the **VOL** buttons to program the timer. (Use the **CH** buttons to move from line to line).
 - Day - the day(s) for the monitor/receiver to turn ON.
 - Mon - Fri
 - Sat - Sun
 - Daily
 - Sun, Mon, Tue, Wed, Thr, Fri or Sat
 - Evr Sun, Evr Mon, Evr Tue, Evr Wed, Evr Thr, Evr Fri or Evr Sat
 - On - the time when the monitor/receiver turns ON.
 - Off - the time when the monitor/receiver turns OFF.
 - Ch - the channel the monitor/receiver tunes to
- Note:** The timer(s) can only access channels stored in the Channel Scan Memory.
- Set - YES (to activate) or NO (to deactivate)

Timer Options (cont.)

6. Press the **CH**  button to move to the other timer's settings.
7. Press the **ACTION** button twice to exit menus.

Note: If the timer turns on while the monitor/receiver is on, it will automatically tune to the programmed channel.

**Turn Off After 90 Minutes**

The monitor/receiver will automatically turn OFF after 90 minutes when turned ON by the timer. Programming an OFF time under the Timer settings or pressing any key during the 90 minutes will cancel this automatic feature.



Input Select

This option allows either a TV or Video input mode to be selected.

Procedure

1. Press the **ACTION** button.
2. Press the **CH** and/or **VOL** buttons to highlight the Input Select icon.
3. Press the **ACTION** button to display the Input Select menu.

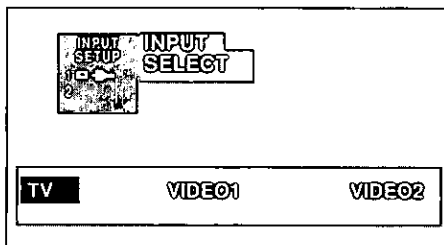

4. Press the **VOL** buttons to select TV, Video1 or Video2.
5. Press the **ACTION** button twice to exit menus.



Favorite Channel

Chan (Channel) Scan

This option accesses the channels stored in memory for All or Fav (Favorite) channels.

Note: Channels must be programmed into Channel Scan Memory before the channel options can be used.

Procedure

1. Press the **ACTION** button.
2. Press the **CH** and/or **VOL** buttons to highlight the Favorite Channel icon.
3. Press the **ACTION** button to display the Favorite Channel menu.

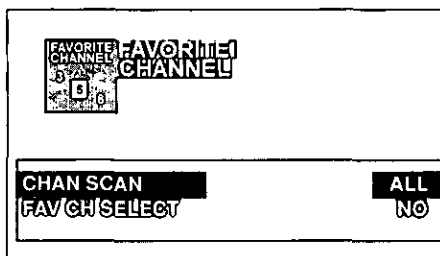

4. Press the **CH** buttons to highlight CHAN SCAN.
5. Press the **VOL** buttons to select ALL or FAV.
 - All - the **CH** buttons will access all channels in Channel Scan Memory.
 - Fav - the **CH** buttons will only access the channels in the Favorite Channel Select Memory.
6. Press the **ACTION** button twice to exit menus.

Fav (Favorite) Ch (Channel) Select

This option allows the programming of up to 15 favorite channels to be scanned when using the **CH** buttons.

1. Press the **ACTION** button.
2. Press the **CH** and/or **VOL** buttons to highlight the Favorite Channel icon.
3. Press the **ACTION** button to display the Favorite Channel menu.

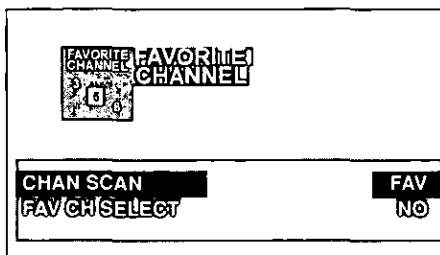

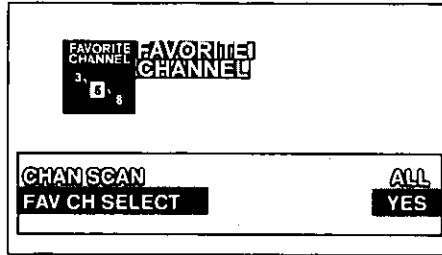

Favorite Channel (cont.)

4. Press the **CH** buttons to highlight CHAN SCAN.
5. Press the **VOL** buttons to select FAV.
6. Press the **CH** buttons to highlight FAV CH SELECT.

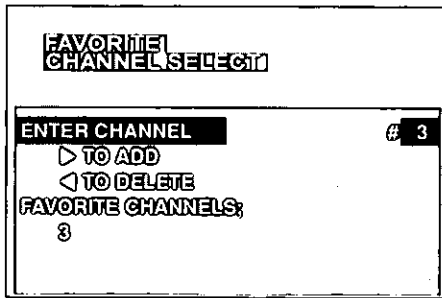

7. Press the **VOL** buttons to select YES and display the Favorite Channel Select menu.



8. Use the numeric keypad on the remote control or the **CH** buttons to select channels.
 9. Press the **VOL**  button to add a channel and the **VOL**  button to delete a channel from Favorite Channel Select Memory.
 10. Repeat steps 8 and 9 to add and delete channels.
- Note:** Up to 15 channels can be stored in the Favorite Channel Select Memory.
11. Press the **ACTION** button twice to exit menus.

Channel Caption



Preset Caption

This option allows channel numbers to be assigned to 56 preset television station captions. (For example, NBC, CNN, ESPN, etc.).

Procedure

1. Press the **ACTION** button.
2. Press the **CH** and/or **VOL** buttons to highlight the Channel Caption icon.
3. Press the **ACTION** button to display the Channel Caption menu.

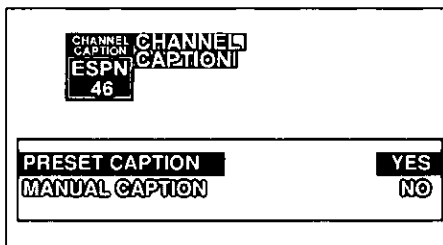

4. Press the **CH** buttons to highlight PRESET CAPTION.
5. Press the **VOL** buttons to display the Preset Caption menu.

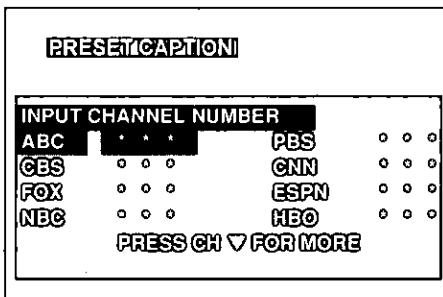

6. Press the **CH** buttons to highlight a preset caption.

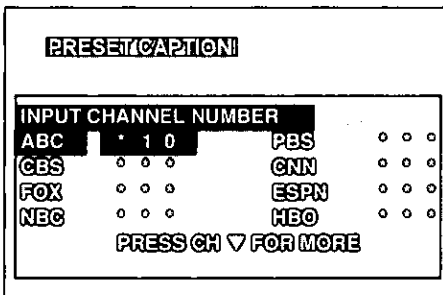

7. Use the numeric keypad on the remote control to assign a channel number to the appropriate preset caption. (Refer to your local TV guide).

Note: To delete a channel, press the **VOL**  button while the channel number is highlighted.

Channel Caption (cont.)

8. Repeat step 7 to assign channel numbers to preset captions.
9. Press the **ACTION** button repeatedly to exit menus.

Manual Caption

This option allows up to 30 station call names (KPBS, KHON, etc.) to be stored into memory (up to 4 characters long). The call name and channel number will then display when changing channels or when pressing the **RECALL** button on the remote control.

Procedure

1. Press the **ACTION** button.
2. Press the **CH** and/or **VOL** buttons to highlight the Channel Caption icon.
3. Press the **ACTION** button to display the Channel Caption menu.

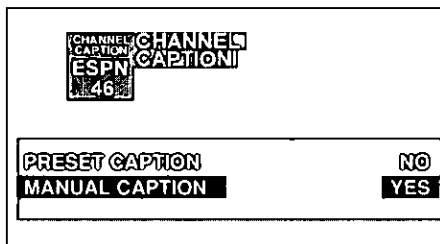

4. Press the **CH** buttons to highlight MANUAL CAPTION.
5. Press the **VOL** buttons to display the Manual Caption menu.

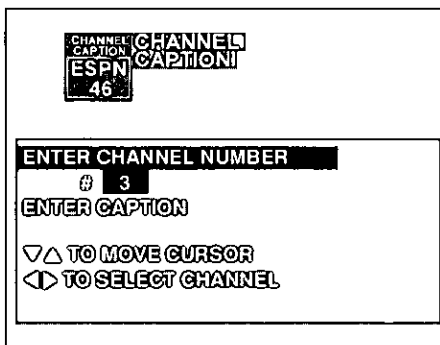

6. Use the numeric keypad on the remote control or the **VOL** buttons to enter a channel number.

Channel Caption (cont.)

7. Press the **CH**  button to highlight ENTER CAPTION.

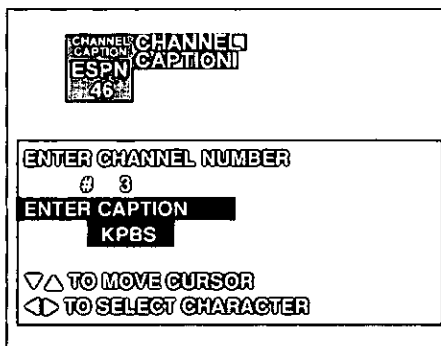



8. Press the **VOL** buttons to select the first character of the channel caption.
Note: To delete a character, use the **CH** buttons to highlight the character, then press the **VOL** buttons until an empty space appears.
9. Press the **CH**  button to move to the second character position.
10. Repeat steps 8 and 9 until the caption is completed (up to 4 characters long).
11. Press the **CH** buttons to highlight ENTER CHANNEL NUMBER again and repeat steps 6 through 10 to continue adding channel captions.
12. Press the **ACTION** button repeatedly to exit menus.

Front Control Panel Lock

This option allows the front control panel of the monitor to be locked. To confirm that the Control Panel Lock is activated, press any button but the **POWER** button. (The **POWER** button is never disabled).

Note: This option is available only in TV mode.

Procedure

1. Turn the monitor ON.
2. Press the **ACTION** button and **VOL**  button on the control panel simultaneously, then quickly press the **ACTION** button and **CH**  button simultaneously. (There will be no onscreen display).
Note: Buttons should be pressed quickly, then released. Do not hold the buttons down.
3. To deactivate the Control Panel Lock, repeat steps 1 and 2.

Rear PC Input Connections

Follow the procedure below to connect your monitor's rear PC input connections to a computer.

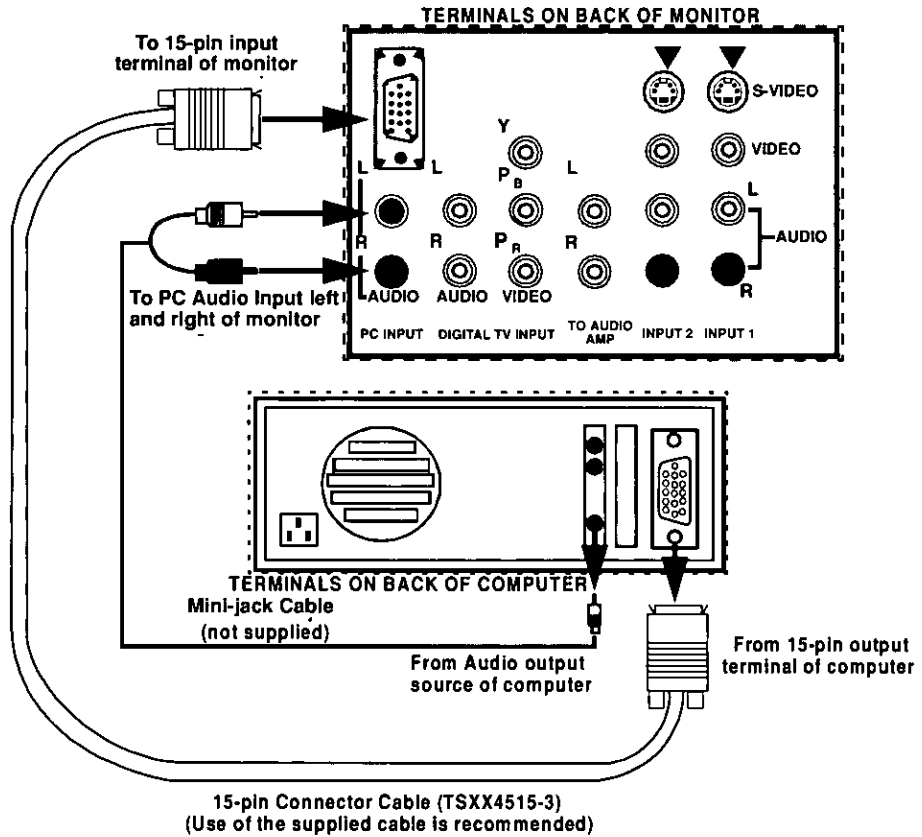

Procedure

1. Connect the 15-pin connector cable (the supplied cable meets FCC standards) from the computer output terminal to the monitor input terminal.
2. Connect an audio/video to mini-jack cable from the computer audio output jack to the monitor PC INPUT AUDIO L and R jacks.
3. Select PC (rear) mode from the TV/PC/DTV menu. (Refer to the TV/PC/DTV section of the manual).

Note: To operate the monitor and computer properly, refer to the instructions furnished with the computer.



Scrambled Monitor Image

If the monitor image is scrambled after connecting the computer, refer to the troubleshooting section for information about changing the computer's resolution.

Front PC Input Connections

Follow the procedure below to connect your monitor's front PC input connections to a computer.

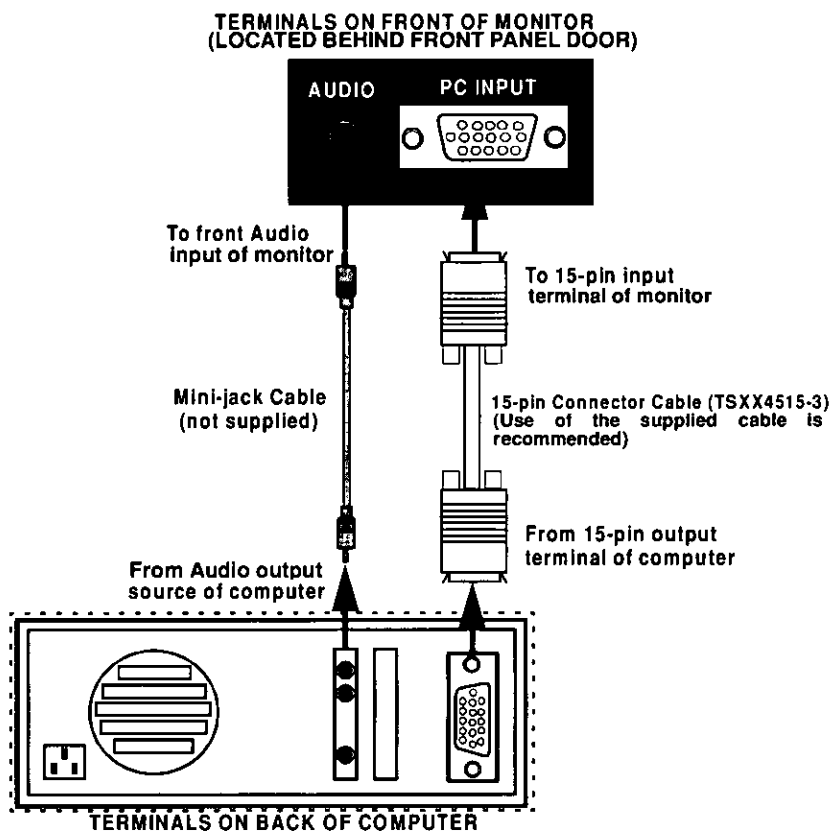

Procedure

1. Connect the 15-pin connector cable (the supplied cable meets FCC standards) from the computer output terminal to the monitor input terminal.
2. Connect an audio/video to mini-jack cable from the computer audio output jack to the monitor audio input jack.
3. Select PC (front) mode from the TV/PC/DTV menu. (Refer to the TV/PC/DTV section of the manual).

Note: To operate the monitor and computer properly, refer to the instructions furnished with the computer.



Scrambled Monitor Image

If the monitor image is scrambled after connecting the computer, refer to the troubleshooting section for information about changing the computer's resolution.

Trilingual Animated Icons

The icons allow the user to access menus to configure the monitor to operate with external components connected to the terminals on the back (or front) of the monitor.

PC Mode Icons

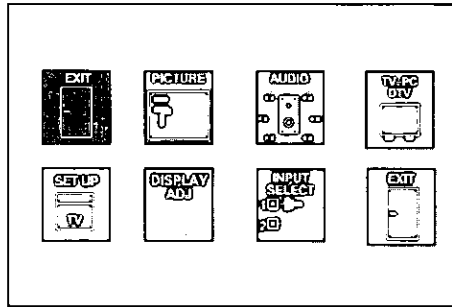

Note: Only the selected icon, which appears in red, will be animated.

 **PC Mode Icons**

An input signal must be connected to the input terminals of the monitor to access the PC Mode icon menu. When there is no signal, the icon menu will appear small and distorted. **This is a normal condition.**

Menu Navigation

- Use **CH** (channel) and **VOL** (volume) buttons to highlight icons.
 - Use **CH** (channel) buttons to highlight options within a submenu.
 - Use **VOL** (volume) buttons to select and adjust options within a submenu.



Picture Adjustments

Picture Norm

To reset the video adjustments to factory preset levels, follow the procedure below.

1. Press the **ACTION** button.
2. Press the **CH** and/or **VOL** buttons to highlight the Picture icon.
3. Press the **ACTION** button to display the Video menu.

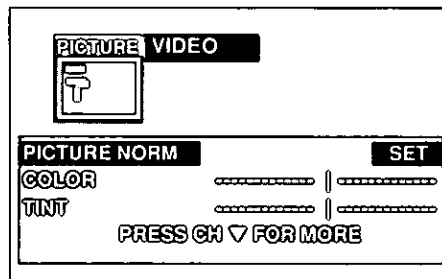

Picture Adjustments (cont.)

4. Press the **CH** buttons to highlight PICTURE NORM.
5. Press the **VOL** buttons to select SET to reset video adjustments to factory preset levels.
6. Press the **ACTION** button twice to exit menus.

Video Adjustments

The video adjustments are factory set to certain levels. To change the preset levels, follow the procedure below.

Procedure

1. Press the **ACTION** button.
2. Press the **CH** and/or **VOL** buttons to highlight the Picture icon.
3. Press the **ACTION** button to display the Video menu.

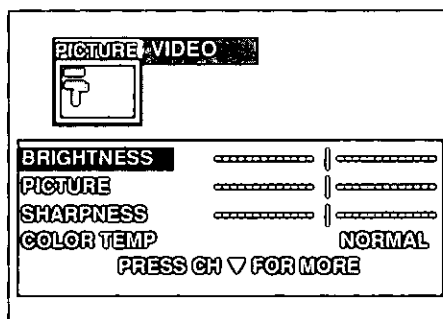
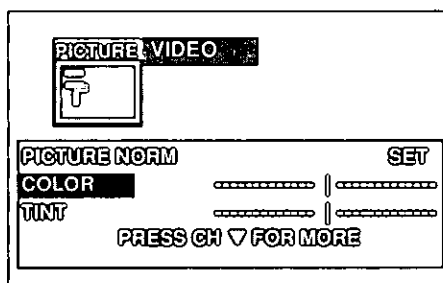

4. Press the **CH** buttons to highlight a video adjustment.
 - Note:** Press the **CH**  button to display more adjustment options.
 - Color - adjust for color intensity
 - Tint - adjust for natural flesh tones
 - Brightness - adjust dark areas for crisp detail
 - Picture - adjust white areas of the picture
 - Sharpness - adjust clarity of outline detail
5. Press the **VOL** buttons to adjust the setting.
6. Press the **ACTION** button twice to exit menus.

Picture Adjustments (cont.)

Other Adjustments

To change the color temp (temperature), follow the procedure below.

Procedure

1. Press the **ACTION** button.
2. Press the **CH** and/or **VOL** buttons to highlight the Picture icon.
3. Press the **ACTION** button to display the Video menu.
4. Press the **CH**  button to display more adjustment options.

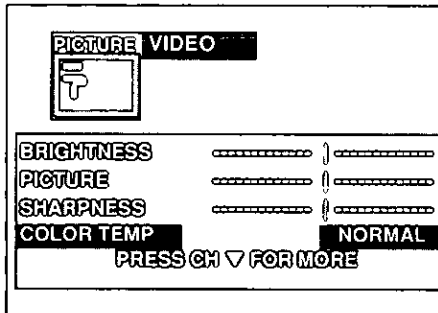

5. Press the **CH** buttons to highlight **COLOR TEMP**.
6. Press the **VOL** buttons to change the color temperature.
 - Normal - no tint
 - Warm - reddish tint
 - Cool - bluish tint
7. Press the **ACTION** button twice to exit menus.

Audio Adjustments



Audio Norm

To reset the audio adjustments to factory preset levels, follow the procedure below.

Procedure

1. Press the **ACTION** button.
2. Press the **CH** and/or **VOL** buttons to highlight the Audio icon.
3. Press the **ACTION** button to display the Audio menu.

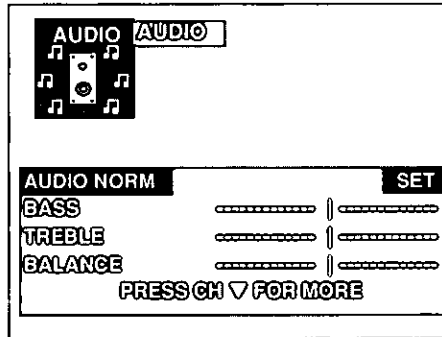

4. Press the **CH** buttons to highlight AUDIO NORM.
5. Press the **VOL** buttons to select SET to reset audio adjustments to factory preset levels.
6. Press the **ACTION** button twice to exit menus.

Audio Adjustments

The audio adjustments are factory set to certain levels. To change the preset levels, follow the procedure below.

Procedure

1. Press the **ACTION** button.
2. Press the **CH** and/or **VOL** buttons to highlight the Audio icon.
3. Press the **ACTION** button to display the Audio menu.

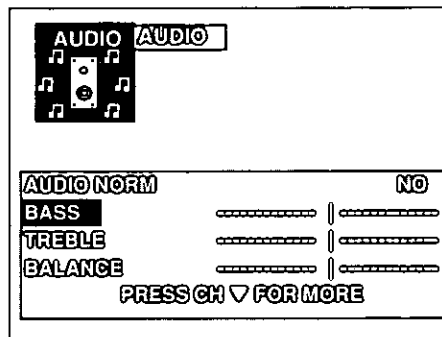

Audio Adjustments (cont.)

4. Press the **CH** buttons to highlight an audio adjustment.
 - Bass - increase or decrease the bass response
 - Treble - increase or decrease the treble response
 - Balance - emphasize the right /left speaker volume.
5. Press the **VOL** buttons to adjust the setting.
6. Press the **ACTION** button twice to exit the menus.

Other Adjustments

To activate/deactivate internal speakers, surround sound or AI sound, follow the procedures below.

Speaker

This option turns the internal monitor/receiver speakers ON or OFF when the monitor/receiver is connected to an external audio amplifier. (Refer to To Audio Amp section of the manual).

Procedure

1. Press the **ACTION** button.
2. Press the **CH** and/or **VOL** buttons to highlight the Audio icon.
3. Press the **ACTION** button to display the Audio menu.
4. Press the **CH**  button to display more adjustment options.

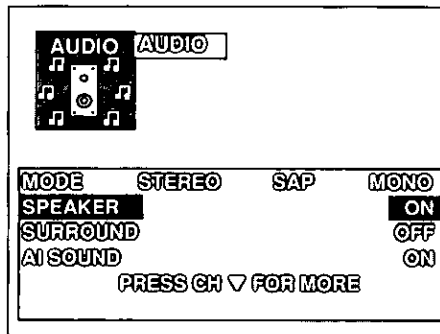

5. Press the **CH** buttons to highlight **SPEAKER**.
6. Press the **VOL** buttons to turn the speakers ON or OFF.
 - On - monitor/receiver speakers operate normally
 - Off&VAO (variable audio out) - monitor/receiver speakers are OFF and the audio is adjusted through the monitor/receiver
 - Off&FAO (fixed audio out) - monitor/receiver speakers are OFF and audio is adjusted through the external amplifier
7. Press the **ACTION** button twice to exit menus.

Audio Adjustments (cont.)

Surround

This option turns the surround sound feature ON or OFF. Surround sound enhances the audio response when listening to stereo broadcasts.

Procedure

1. Press the **ACTION** button.
2. Press the **CH** and/or **VOL** buttons to highlight the Audio icon.
3. Press the **ACTION** button to display the Audio menu.
4. Press the **CH**  button to display more adjustment options.

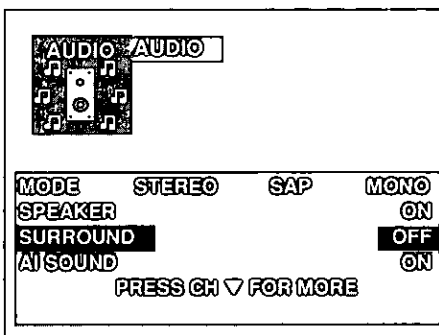

5. Press the **CH** buttons to highlight SURROUND.
6. Press the **VOL** buttons to select ON or OFF.
7. Press the **ACTION** button twice to exit menus.

AI Sound

This option allows the monitor/receiver to maintain a constant sound level between programs with different sound levels.

Procedure

1. Press the **ACTION** button.
2. Press the **CH** and/or **VOL** buttons to highlight the Audio icon.
3. Press the **ACTION** button to display the Audio menu.
4. Press the **CH**  button to display more adjustment options.

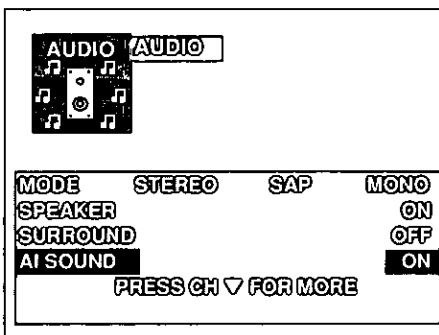

5. Press the **CH** buttons to highlight AI SOUND.
6. Press the **VOL** buttons to select ON or OFF.
7. Press the **ACTION** button twice to exit menus.



TV/PC/DTV Mode

The monitor/receiver can be set to three (TV, PC or DTV) different modes. To select a mode, follow the procedure below.

Procedure

1. Press the **ACTION** button.
2. Press the **CH** and/or **VOL** buttons to highlight the TV/PC/DTV icon.
3. Press the **ACTION** button to display the TV/PC/DTV mode menu.

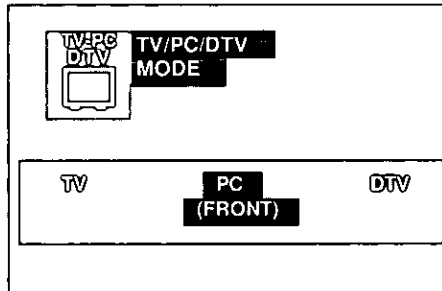

4. Press the **VOL** buttons to select a mode.
 - TV - television mode
 - PC - computer mode

Note: Press the **INPUT** button to select front or rear PC inputs.

 - DTV - digital television mode
5. Press the **ACTION** button twice to exit menus.

Set Up Options

**Auto Power On**

This option allows the monitor/receiver to turn ON when AC power is applied. Activating the Auto Power On option will cancel the time and timer control settings.

Note: The *TIMER CONTROL* icon will be replaced with an *EXIT* icon in the TV Mode Main Menu.

Procedure

1. Press the **ACTION** button.
2. Press the **CH** and/or **VOL** buttons to highlight the Set Up icon.
3. Press the **ACTION** button to display the Set Up menu.

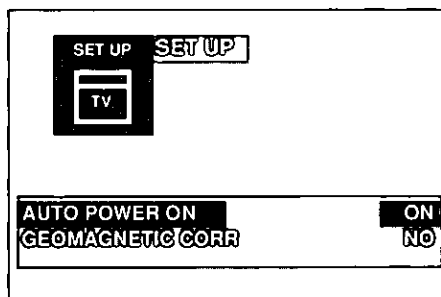

4. Press the **CH** buttons to highlight AUTO POWER ON.
5. Press the **VOL** buttons to select ON or OFF.
6. Press the **ACTION** button twice to exit menus.

Geomagnetic Corr (Correction)

This monitor has a special adjustment option that compensates for the earth's geomagnetic field. Although the adjustment is preset at the factory, a correction may be needed if the monitor is moved.

Procedure

1. Press the **ACTION** button.
2. Press the **CH** and/or **VOL** buttons to highlight the Set Up icon.
3. Press the **ACTION** button to display the Set Up menu.

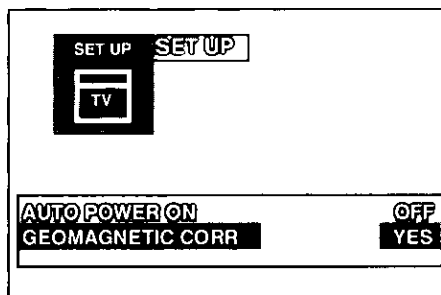

Set Up Options (cont.)

4. Press the **CH** buttons to highlight GEOMETRIC CORR.
5. Press the **VOL** buttons to select YES and display the tilt adjustment bar menu.

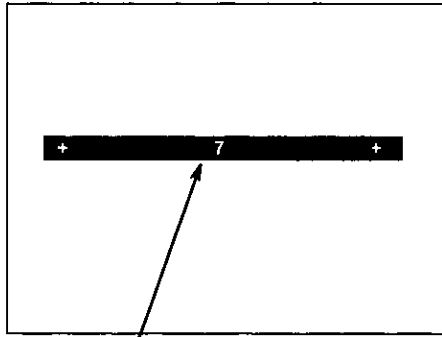

tilt adjustment bar

6. Press the **VOL** buttons to adjust the tilt adjustment bar until it is parallel to the bottom of the picture frame.
Note: Discoloration may be visible in the picture corners if the tilt adjustment bar is not parallel to the bottom of the picture frame.
7. Press the **ACTION** button twice to exit menus.



Display Adj (Adjustment)

This option is used to adjust the image on the monitor.

Procedure

1. Press the **ACTION** button.
2. Press the **CH** and/or **VOL** buttons to highlight the Display Adj icon.
3. Press the **ACTION** button to display the Display Adj menu.

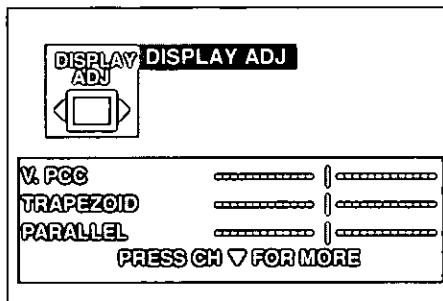
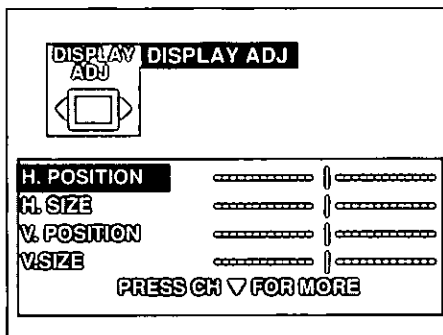







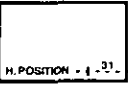
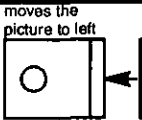
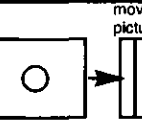

4. Press the **CH** buttons to highlight a display adjustment.⁶1

Display Adj (Adjustment) (cont.)

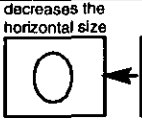
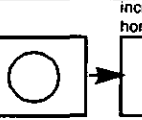
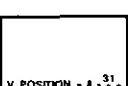
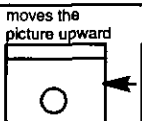
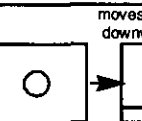
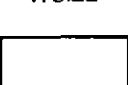
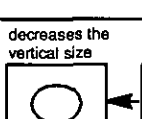
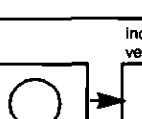
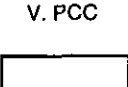
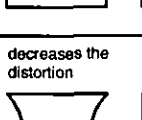
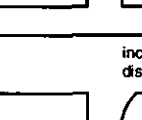
5. Press the VOL buttons to adjust the setting

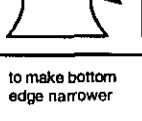
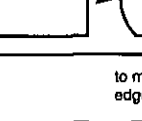
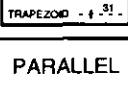
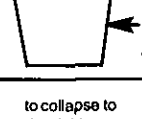
Display Adjust Chart

Selection	Press  	
H. POSITION 	moves the picture to left 	moves the picture to right 
H. SIZE 	decreases the horizontal size 	increases the horizontal size 
V. POSITION 	moves the picture upward 	moves the picture downward 
V. SIZE 	decreases the vertical size 	increases the vertical size 
V. PCC 	decreases the distortion 	increases the distortion 
TRAPEZOID 	to make bottom edge narrower 	to make top edge narrower 
PARALLEL 	to collapse to the right 	to collapse to the left 

6. Press the ACTION button twice to exit menus.



Input Select

This option is used to select either Front PC Input or Rear PC Input mode.

Procedure

1. Press the **ACTION** button.
2. Press the **CH** and/or **VOL** buttons to highlight the Input Select icon.
3. Press the **ACTION** button to display the Input Select menu.

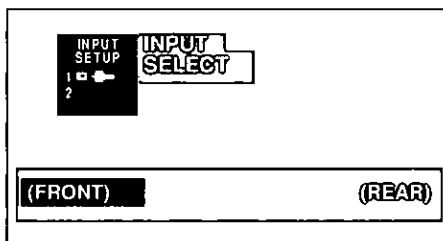

4. Press the **VOL** buttons to select FRONT or REAR.

Note: Front or Rear PC Input mode can also be selected by pressing the **INPUT** button while the Input Select menu is displayed.

5. Press the **ACTION** button twice to exit menus.

Component Video Connection

Follow the procedure below to connect your monitor to component video devices.

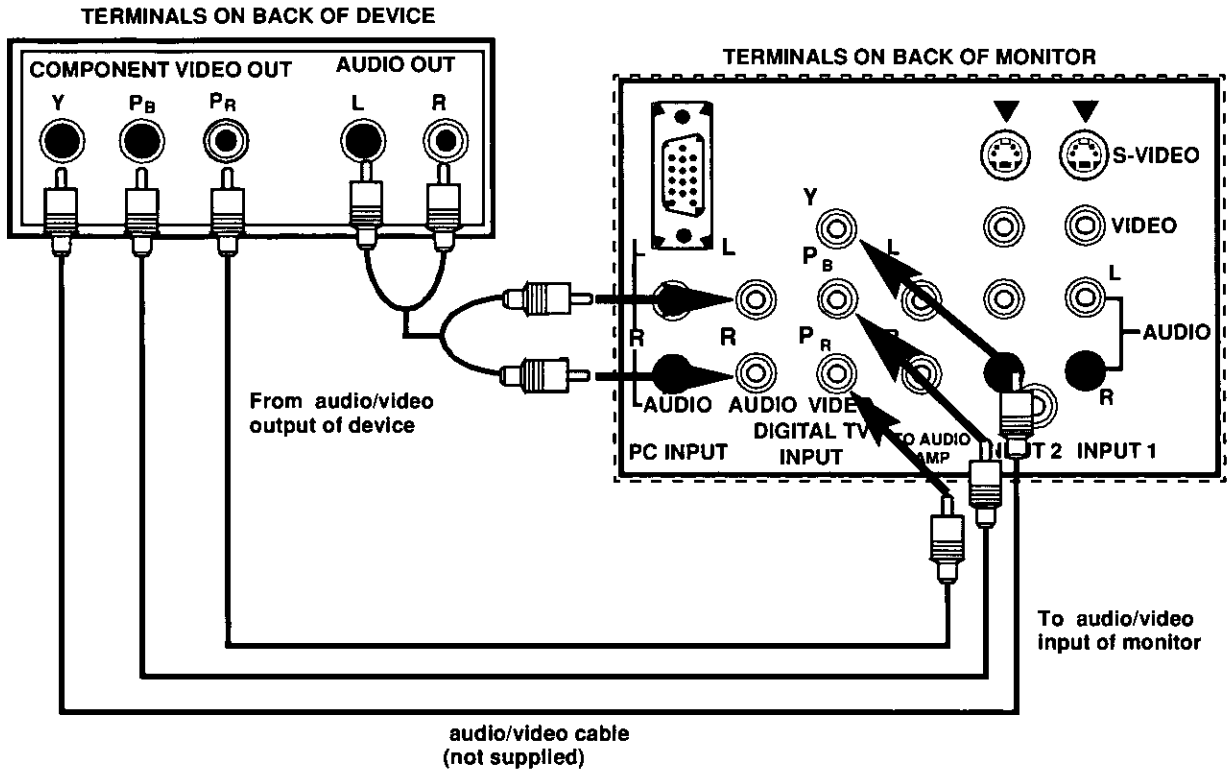

Procedure

1. Connect the audio/video cable from the component video output terminals to the monitor DIGITAL TV INPUT terminals.
2. Connect the audio cable from the component video audio out R and L jacks to the monitor DIGITAL TV INPUT audio R and L jacks.
3. Select DTV mode from the TV/PC/DTV menu. (Refer to the TV/PC/DTV section of the manual).

Note: To operate the monitor with the component video devices properly, refer to the instructions furnished with the component video device.

Trilingual Animated Icons

The icons allow the user to access menus to configure the monitor to operate with component video devices.

DTV Mode Icons

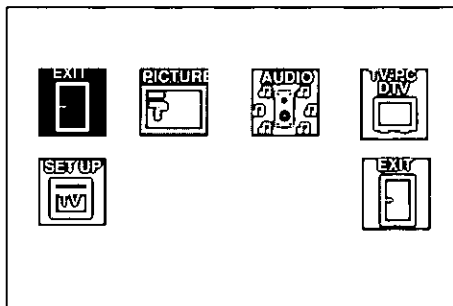

Note: Only the selected icon, which appears in red, will be animated.

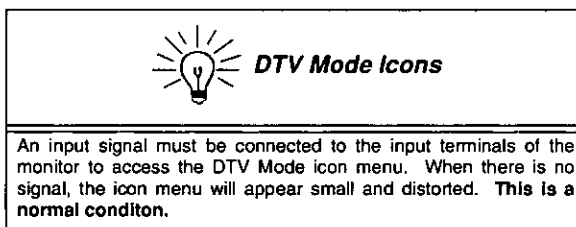

Menu Navigation

- Use **CH** (channel) and **VOL** (volume) buttons to highlight icons.
 - Use **CH** (channel) buttons to highlight options within a submenu.
 - Use **VOL** (volume) buttons to select and adjust options within a submenu.



Picture Adjustments

Picture Norm

To reset the video adjustments to factory preset levels, follow the procedure below.

1. Press the **ACTION** button.
2. Press the **CH** and/or **VOL** buttons to highlight the Picture icon.
3. Press the **ACTION** button to display the Video menu.

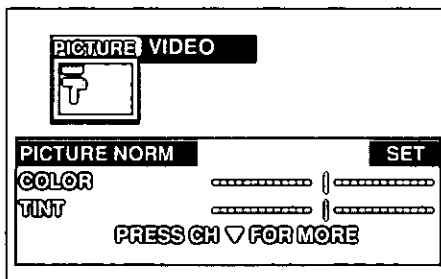

Picture Adjustments (cont.)

4. Press the **CH** buttons to highlight **PICTURE NORM**.
5. Press the **VOL** buttons to select **SET** to reset video adjustments to factory preset levels.
6. Press the **ACTION** button twice to exit menus.

Video Adjustments

The video adjustments are factory set to certain levels. To change the preset levels, follow the procedure below.

Procedure

1. Press the **ACTION** button.
2. Press the **CH** and/or **VOL** buttons to highlight the Picture icon.
3. Press the **ACTION** button to display the Video menu.

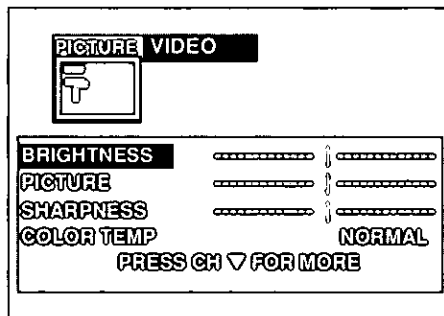
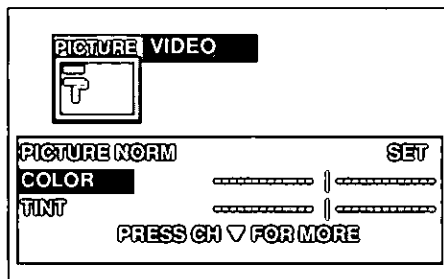

4. Press the **CH** buttons to highlight a video adjustment.

Note: Press the **CH**  button to display more adjustment options.

 - Color - adjust for color intensity
 - Tint - adjust for natural flesh tones
 - Brightness - adjust dark areas for crisp detail
 - Picture - adjust white areas of the picture
 - Sharpness - adjust clarity of outline detail
5. Press the **VOL** buttons to adjust the setting.
6. Press the **ACTION** button twice to exit menus.

Picture Adjustments (cont.)

Other Adjustments

To change the color temp (temperature), follow the procedure below.

Color Temp

This option changes the color temperature.

Procedure

1. Press the **ACTION** button.
2. Press the **CH** and/or **VOL** buttons to highlight the Picture icon.
3. Press the **ACTION** button to display the Video menu.
4. Press the **CH**  button to display more adjustment options.

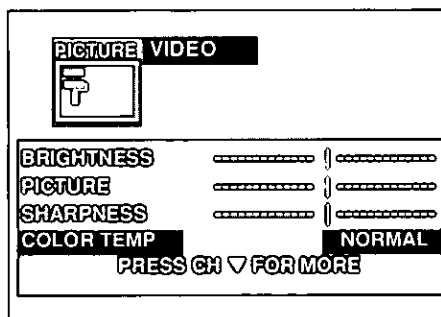

5. Press the **CH** buttons to highlight **COLOR TEMP**.
6. Press the **VOL** buttons to change the color temperature.
 - Normal - no tint
 - Warm - reddish tint
 - Cool - bluish tint
7. Press the **ACTION** button twice to exit menus.



Audio Adjustments

Audio Norm

To reset the audio adjustments to factory preset levels, follow the procedure below.

Procedure

1. Press the **ACTION** button.
2. Press the **CH** and/or **VOL** buttons to highlight the Audio icon.
3. Press the **ACTION** button to display the Audio menu.

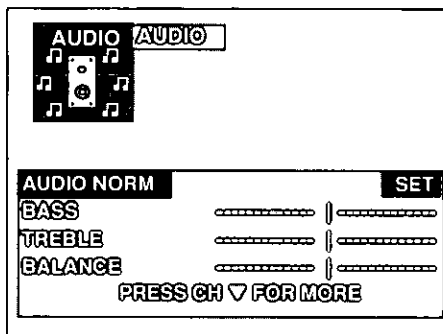

4. Press the **CH** buttons to highlight AUDIO NORM.
5. Press the **VOL** buttons to select SET to reset audio adjustments to factory preset levels.
6. Press the **ACTION** button twice to exit menus.

Audio Adjustments

The audio adjustments are factory set to certain levels. To change the preset levels, follow the procedure below.

Procedure

1. Press the **ACTION** button.
2. Press the **CH** and/or **VOL** buttons to highlight the Audio icon.
3. Press the **ACTION** button to display the Audio menu.

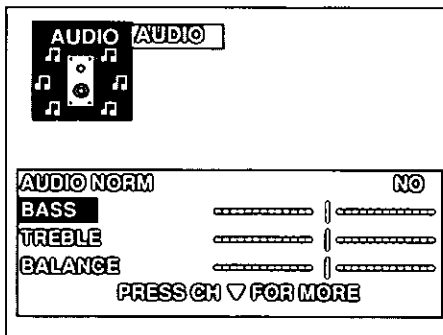

Audio Adjustments (cont.)

4. Press the **CH** buttons to highlight an audio adjustment.
 - Bass - increase or decrease the bass response
 - Treble - increase or decrease the treble response
 - Balance - emphasize the right /left speaker volume.
5. Press the **VOL** buttons to adjust the setting.
6. Press the **ACTION** button twice to exit the menus.

Other Adjustments

To activate/deactivate internal speakers, surround sound or AI sound, follow the procedures below.

Speaker

This option turns the internal monitor/receiver speakers ON or OFF when the monitor/receiver is connected to an external audio amplifier. (Refer to To Audio Amp section of the manual).

Procedure

1. Press the **ACTION** button.
2. Press the **CH** and/or **VOL** buttons to highlight the Audio icon.
3. Press the **ACTION** button to display the Audio menu.
4. Press the **CH**  button to display more adjustment options.

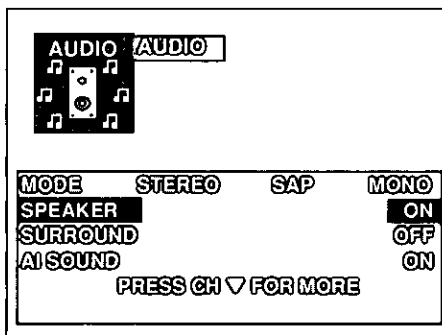

5. Press the **CH** buttons to highlight **SPEAKER**.
6. Press the **VOL** buttons to turn the speakers ON or OFF.
 - On - monitor/receiver speakers operate normally
 - Off&VAO (variable audio out) - monitor/receiver speakers are OFF and the audio is adjusted through the monitor/receiver
 - Off&FAO (fixed audio out) - monitor/receiver speakers are OFF and audio is adjusted through the external amplifier
7. Press the **ACTION** button twice to exit menus.

Audio Adjustments (cont.)

Surround

This option turns the surround sound feature ON or OFF. Surround sound enhances the audio response when listening to stereo broadcasts.

Procedure

1. Press the **ACTION** button.
2. Press the **CH** and/or **VOL** buttons to highlight the Audio icon.
3. Press the **ACTION** button to display the Audio menu.
4. Press the **CH**  button to display more adjustment options.

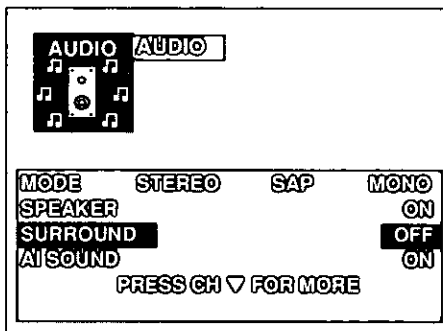

5. Press the **CH** buttons to highlight SURROUND.
6. Press the **VOL** buttons to select ON or OFF.
7. Press the **ACTION** button twice to exit menus.

AI Sound

This option allows the monitor/receiver to maintain a constant sound level between programs with different sound levels.

Procedure

1. Press the **ACTION** button.
2. Press the **CH** and/or **VOL** buttons to highlight the Audio icon.
3. Press the **ACTION** button to display the Audio menu.
4. Press the **CH**  button to display more adjustment options.

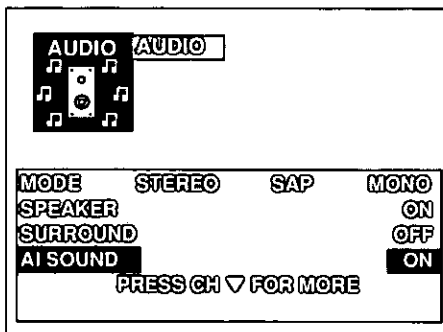

5. Press the **CH** buttons to highlight AI SOUND.
6. Press the **VOL** buttons to select ON or OFF.
7. Press the **ACTION** button twice to exit menus.

TV/PC/DTV Mode



The monitor/receiver can be set to three (TV, PC or DTV) different modes. To select a mode, follow the procedure below.

Procedure

1. Press the **ACTION** button.
2. Press the **CH** and/or **VOL** buttons to highlight the TV/PC/DTV icon.
3. Press the **ACTION** button to display the TV/PC/DTV mode menu.

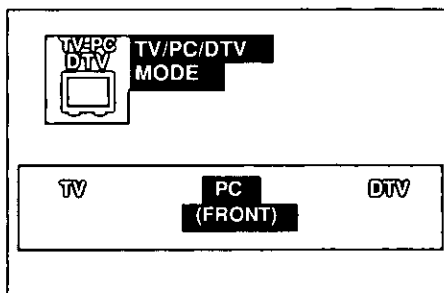

4. Press the **VOL** buttons to select a mode.
 - TV - television mode
 - PC - computer mode

Note: Press the **INPUT** button to select front or rear PC inputs.

- DTV - digital television mode
5. Press the **ACTION** button twice to exit menus.



Set Up Options

Auto Power On

This option allows the monitor/receiver to turn ON when AC power is applied. Activating the Auto Power On option will cancel the time and timer control settings.

Note: The *TIMER CONTROL* icon will be replaced with an *EXIT* icon in the TV Mode Main Menu.

Procedure

1. Press the **ACTION** button.
2. Press the **CH** and/or **VOL** buttons to highlight the Set Up icon.
3. Press the **ACTION** button to display the Set Up menu.

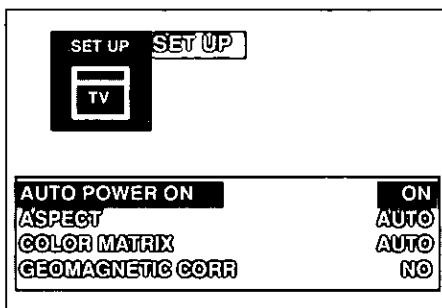

4. Press the **CH** buttons to highlight **AUTO POWER ON**.
5. Press the **VOL** buttons to select **ON** or **OFF**.
6. Press the **ACTION** button twice to exit menus.

Aspect Ratio

This option is used to change the aspect ratio (picture display shape) of the monitor.

Procedure

1. Press the **ACTION** button.
2. Press the **CH** and/or **VOL** buttons to highlight the Set Up icon.
3. Press the **ACTION** button to display the Set Up menu.

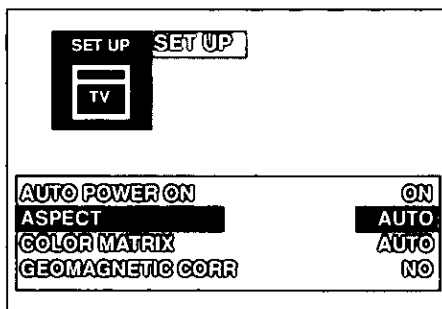

Set Up Options (cont.)

4. Press the **CH** buttons to highlight ASPECT.
5. Press the **VOL** buttons to select an aspect ratio.
 - Auto - automatically selects the aspect ratio based on the source signal being broadcast
 - 16:9 - full screen picture
 - 4:3 - standard picture
6. Press the **ACTION** button twice to exit menus.

Color Matrix

This option is used to change the color palette shown on the monitor.

Procedure

1. Press the **ACTION** button.
2. Press the **CH** and/or **VOL** buttons to highlight the Set Up icon.
3. Press the **ACTION** button to display the Set Up menu.

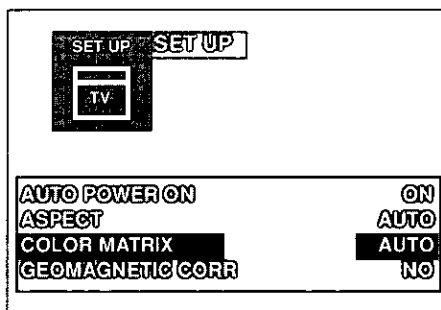

4. Press the **CH** buttons to highlight COLOR MATRIX.
5. Press the **VOL** buttons to select a color matrix.
 - Auto - automatically selects the color palette based on the signal source being broadcast
 - HD - high definition color palette
 - SD - standard definition color palette
6. Press the **ACTION** button twice to exit menus.

Set Up Options (cont.)**Geomagnetic Corr (Correction)**

This monitor has a special adjustment option that compensates for the earth's geomagnetic field. Although the adjustment is preset at the factory, a correction may be needed if the monitor is moved.

Procedure

1. Press the **ACTION** button.
2. Press the **CH** and/or **VOL** buttons to highlight the Set Up icon.
3. Press the **ACTION** button to display the Set Up menu.

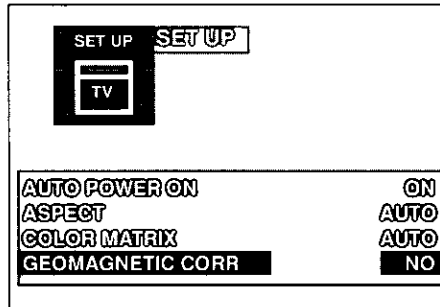

4. Press the **CH** buttons to highlight GEOMETRIC CORR.
5. Press the **VOL** buttons to select YES and display the tilt adjustment bar menu.

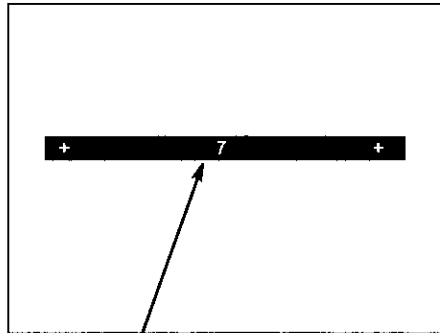

tilt adjustment bar

6. Press the **VOL** buttons to adjust the tilt adjustment bar until it is parallel to the bottom of the picture frame.





















Note: *Discoloration may be visible in the picture corners if the tilt adjustment bar is not parallel to the bottom of the picture frame.*

7. Press the **ACTION** button twice to exit menus.

Troubleshooting

Troubleshooting Chart

Before you call for service, determine the symptoms and follow the suggested solutions below.

Symptoms		Check
Picture	Sound	
 SNOWY PICTURE	 NOISY SOUND	<ul style="list-style-type: none"> - INPUT CONNECTORS SEATED PROPERLY - EQUIPMENT CONNECTED TO INPUT CONNECTIONS - ANTENNA LOCATION AND/OR CONNECTION
 INTERFERENCE	 NOISY SOUND	<ul style="list-style-type: none"> - ELECTRICAL APPLIANCES, LIGHTS, CARS, AND TRUCKS - DIATHERMY AND OTHER MEDICAL EQUIPMENT - VIDEO INPUT CONNECTORS SEATED PROPERLY
 NORMAL PICTURE	 NO SOUND	<ul style="list-style-type: none"> - VOLUME CONTROL SETTING - TV SPEAKERS (IF APPLICABLE) IN THE OFF MODE - AUDIO INPUT CONNECTOR SEATED PROPERLY - TRY ANOTHER CHANNEL
 NO PICTURE	 NO SOUND	<ul style="list-style-type: none"> - THAT AC POWER LINE IS PLUGGED INTO AC OUTLET - BRIGHTNESS AND AUDIO CONTROLS SET PROPERLY - VIDEO AND AUDIO INPUT CONNECTORS SEATED PROPERLY
 NO COLOR	 NORMAL SOUND	<ul style="list-style-type: none"> - COLOR CONTROL SETTINGS - TRY ANOTHER CHANNEL
 NORMAL PICTURE	 NO SOUND	<ul style="list-style-type: none"> - MONITOR/RECEIVER IN VIDEO MODE WITH NO SIGNAL
 CHK MODE	 NORMAL SOUND	<ul style="list-style-type: none"> - PRESS AND HOLD ACTION AND POWER BUTTONS AT THE SAME TIME FOR 5 SECONDS. SCREEN WILL SHUT OFF, THEN TURN BACK ON. TV WILL BE SET TO CHANNEL 3 AND CYCLE THROUGH A SPECIAL TEST
 PC MODE	 NORMAL SOUND	<ul style="list-style-type: none"> - COMPUTER CABLE SEATED PROPERLY - COMPUTER RESOLUTION NOT SET PROPERLY (REFER TO FOLLOWING PAGES FOR SET UP PROCEDURES)
 DISCOLORATION	 NORMAL SOUND	<ul style="list-style-type: none"> - ADJUST GEOMAGNETIC CORRECTION LOCATED IN THE SET UP MENU (IF APPLICABLE)
 DISCOLORED PICTURE	 NORMAL SOUND	<ul style="list-style-type: none"> - MOVE UNSHIELDED SPEAKERS AWAY FROM PICTURE TUBE - TURN OFF SET, ALLOW TO COOL, TURN SET BACK ON

Computer Resolution Adjustments

Windows Version 95/98

The computer's resolution may need to be set to 800 x 600 pixels or less. To change the resolution, follow the procedure below.

Procedure

1. Shut down and restart the computer.
2. When the "starting windows 95" message appears on the screen, quickly press the **F8** key, then press the **Enter** key.

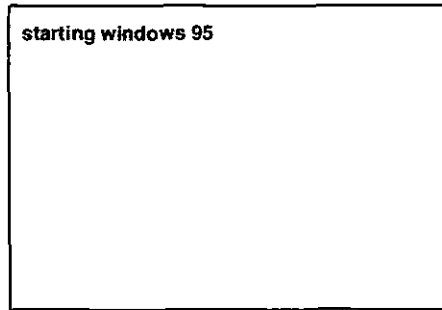

3. The Windows 95 Startup menu will appear. Select "safe mode" by using the **Down** arrow key or by typing in the number.

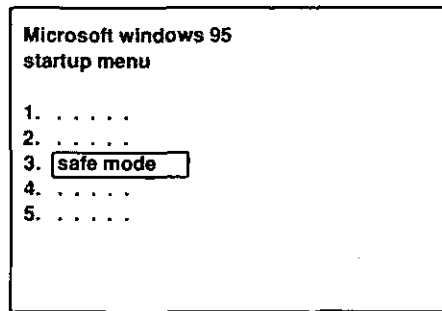

4. Press the **Enter** key.

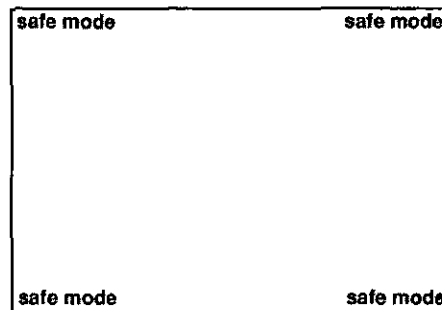

Computer Resolution Adjustments (cont.)

- Click on the **Start** button, located on the taskbar, then highlight "Settings".

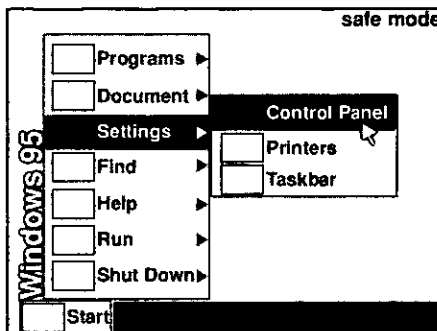

- Highlight and click on "Control Panel".
- Double click on the Display icon. The Display Properties dialog box will appear.

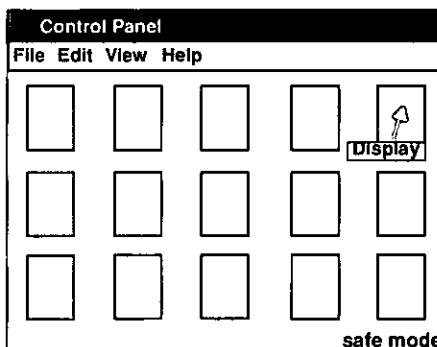

- Click on the tab labeled Settings at the top of the Display Properties dialog box.

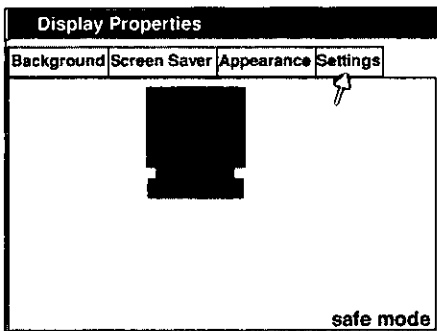

Computer Resolution Adjustments (cont.)

9. In the Desktop Area box, adjust the resolution by moving the slider control to 800 x 600 pixels or less, then click on the **OK** button.

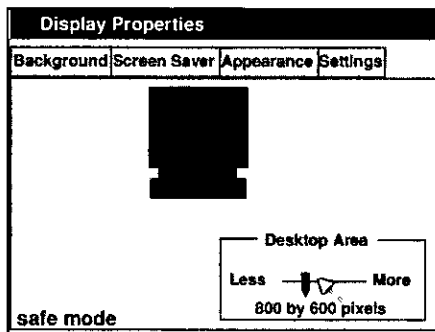

10. The computer must be restarted before the new setting takes effect.

11. Restart Windows 95 in normal mode.

Windows Version 3.x

The computer's resolution may need to be set to VGA. To change the resolution, follow the procedure below.

Procedure

1. Shut down and restart the computer from DOS.

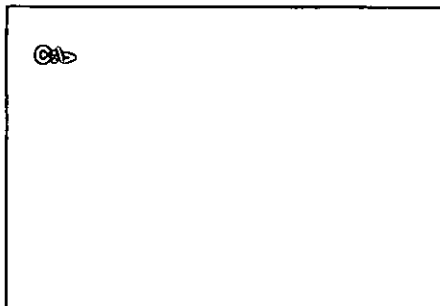

2. At the c:\ prompt, type "cd\windows", then press the **Enter** key.

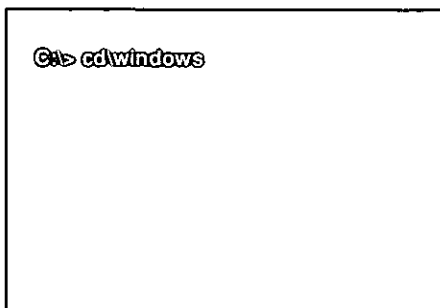

Computer Resolution Adjustments (cont.)

- At the c:\WINDOWS prompt, type "setup," then press the Enter key.

```
C:\WINDOWS> setup
```

- The Windows Setup screen will display. Press the Up or Down arrow key to highlight "Display".

```
Windows Setup
-----
.....
System Information
Computer      MS-DOS system
Display      SVGA
.....
Complete Changes: Accept the configuration shown above
.....
```

- Press the Enter key.
- Press the Enter key, then press the Down arrow key to highlight "VGA."

```
Windows Setup
-----
you have asked to change the type of Display to be installed.
.....
.....
.....
.....
.....
.....
VGA
.....
(to see more of the list press the (F) arrow key)
```

Computer Resolution Adjustments (cont.)

7. Press the **Enter** key. The screen will return to the previous Windows Setup screen. Check that the Display setting has changed to VGA.

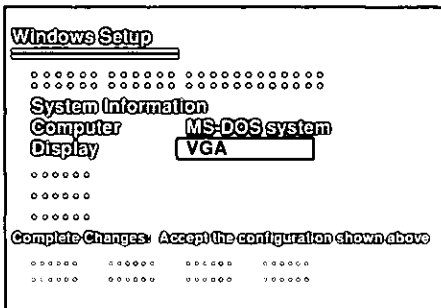

8. Press the Down arrow key to highlight "Accept the configuration shown above," then press the **Enter** key.

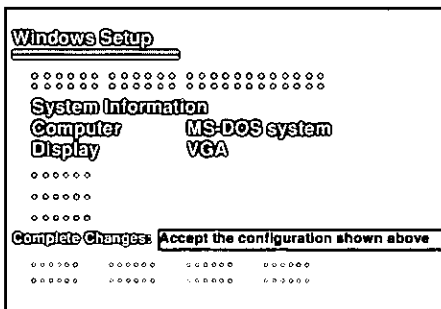

9. Press the **Enter** key to accept the driver. The computer will return to the DOS prompt. Enter Windows 3.x from the c:\WINDOWS prompt.

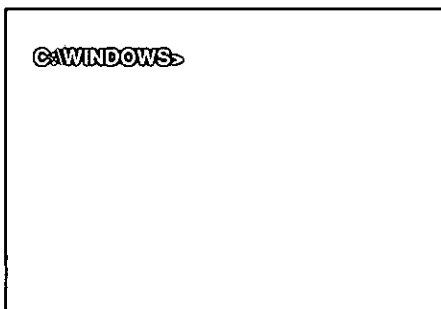

**Panasonic Consumer Electronics Company,
Division of Matsushita
Electric Corporation of America**
One Panasonic Way
Secaucus, New Jersey 07094

Panasonic de Mexico, S.A., de C.V.
Amores No. 1120
Col. Del Valle C.P. 03100
México, D.F.
Tel. (915 ó 615) 488-1000
Fax (915 ó 615) 575-6763, 575-6765

**Panasonic Sales Company
Division of Matsushita Electric
of Puerto Rico Inc. ("PSC")**
Ave. 65 de Infantería , Km 9.5
San Gabriel Industrial Park
Carolina, Puerto Rico 00985
Tel. (787) 750-4300
Fax (787) 768-2910